

connect

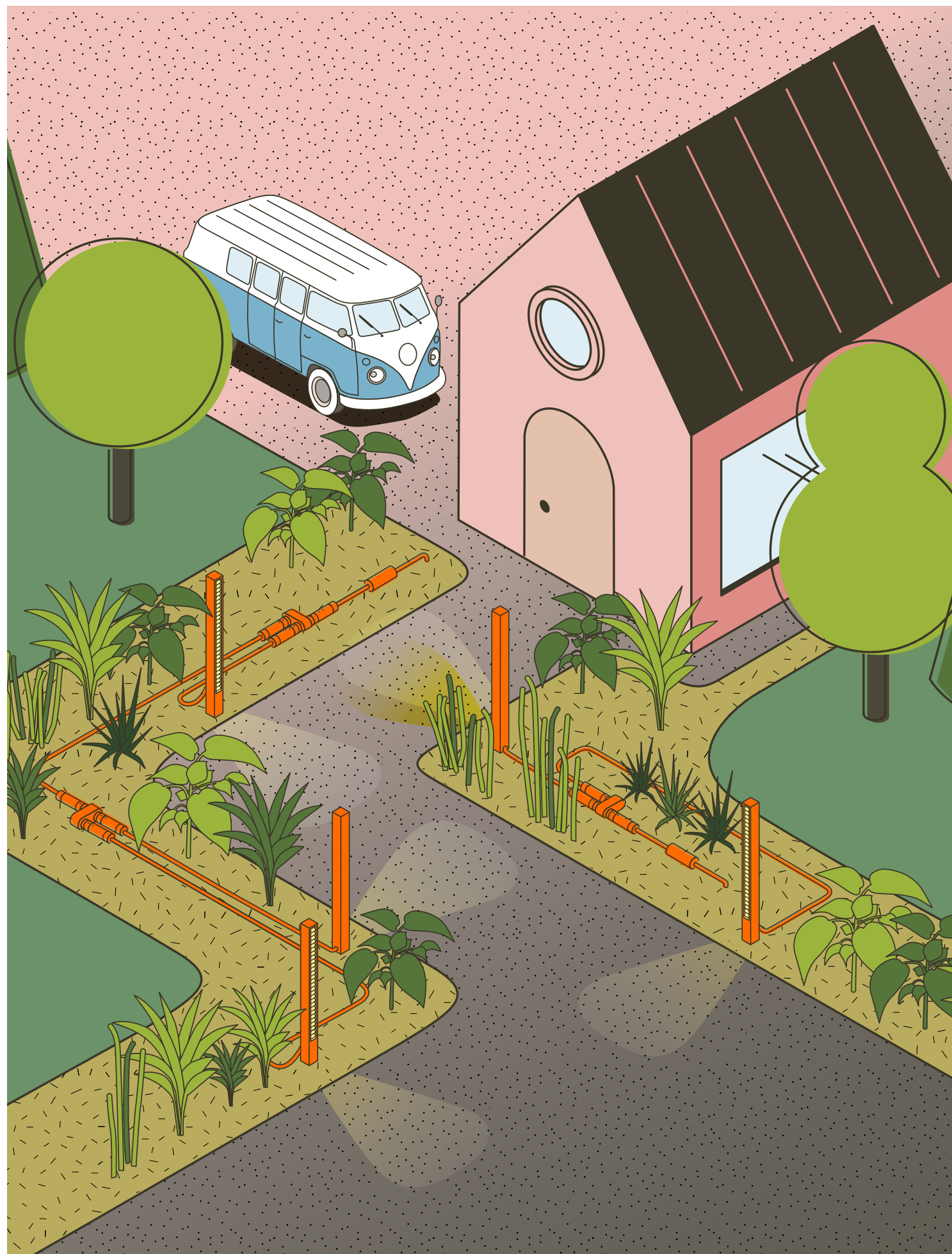

Kein anderes System kombiniert derart viele Vorteile wie IP44.DE connect!  
No other system combines as many advantages as IP44.DE connect.

## Bestens verbunden Best connections

Sein Name sagt es bereits: Mit IP44.DE connect lassen sich all unsere ortsveränderlichen LED-Außenleuchten anschließen, und zwar einfacher und schneller als je zuvor. Eine aufwändige Verlegung von Erdkabeln, Vorinstallationen und teure Montagen entfallen. Verändern sich Bepflanzung, Architektur oder Geschmack, lässt sich das System jederzeit erweitern und verändern. Und damit es draußen sofort losgehen kann, liefern wir unsere Leuchtenmodelle lin, pad, piek, piek lettura, shot, slat spike, stic spike sowie in A + in S gleich mit IP44.DE connect Stecker aus. Intelligentes Detail: In Kombination mit dem IP44.DE Controller ist das System sogar smartfähig!

As the name says, IP44.DE connect can be used to connect all our movable LED outside luminaires, now simpler and faster than ever before. This dispenses entirely with any complicated routing of underground cables, preliminary assembly and expensive installation. It is a system that can be extended and modified at any time to allow for changes in planting, architecture or taste. Our luminaire models lin, pad, piek, piek lettura, shot, slat spike, stic spike, as well as in A + in S come supplied with IP44.DE connect plugs to make them ready for immediate outside use. Smart detail: when combined with the IP44.DE controller, the system can even be used in smart solutions!

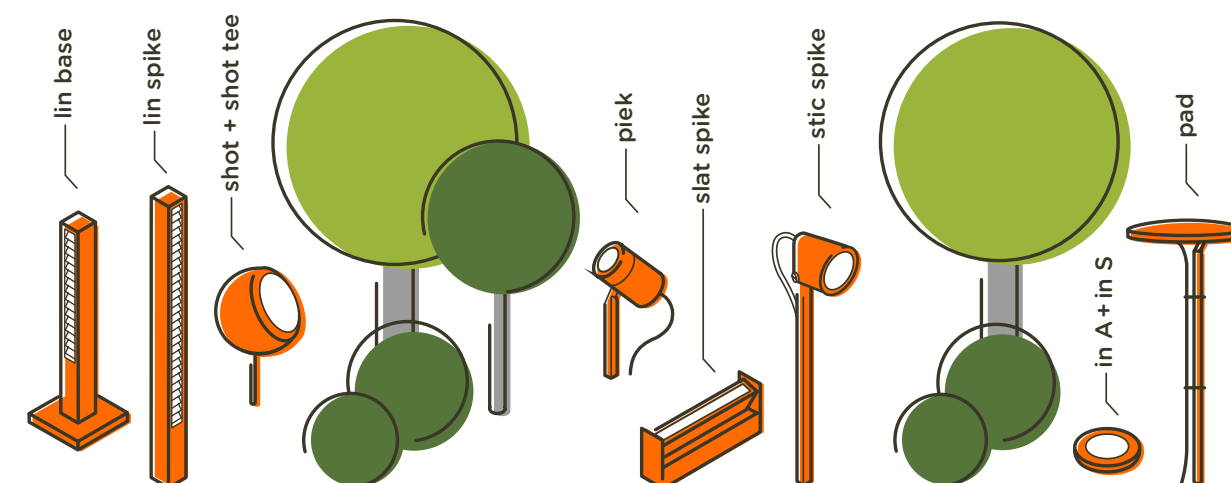
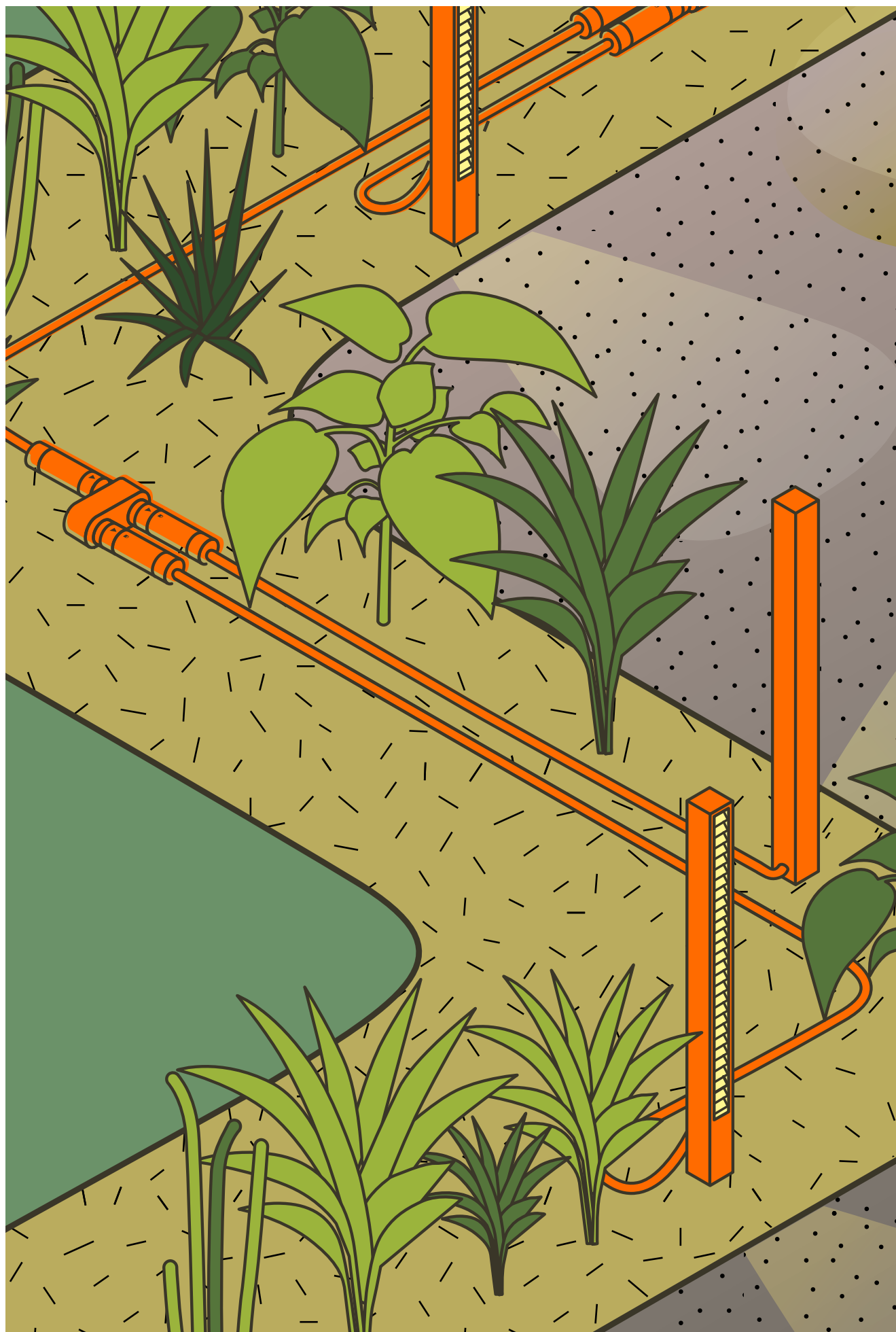

## Anpassungsfähig Adaptable

Von zwei Leuchten für den kleinen Balkon bis zu komplexen Lichtszenarien für große Gärten - IP44.DE connect versorgt sie alle zuverlässig mit Energie.

Unsere Leuchtenmodelle lin, pad, piek, piek lettura, shot, slat spike, stic spike sowie in A + in S werden gleich mit dem passenden Anschluss geliefert. Und wenn die Ansprüche wachsen oder sich die Gartenarchitektur verändert, wächst IP44.DE connect einfach mit. Das System lässt sich jederzeit im Handumdrehen umbauen, erweitern oder auch verkleinern.

From two luminaires on a small balcony to complex light scenarios in large gardens - IP44.DE connect keeps them all supplied reliably with energy.

Our luminaire models lin, pad, piek, piek lettura, shot, slat spike, stic spike, as well as in A + in S come ready supplied with the right connection. And when demands grow or the garden architecture is changed, IP44.DE connect simply grows as well. The system can be modified, extended or even reduced in next to no time.

# 6 gute Gründe für IP44.DE connect

## 6 good reasons for IP44.DE connect

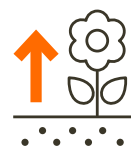

### Simple Verlegung simple routing

IP44.DE connect wird ganz einfach oberirdisch ausgelegt und beispielsweise zwischen immergrünen Bodendeckern verlegt.

IP44.DE connect is simply laid out above ground and routed for example between evergreen ground-cover plants.



### DIY-Montage DIY assembly

Keine hohen Stundenabrechnungen von Fachhandwerkern – dank Do-It-Yourself-Montage.

No need to pay the expensive hourly rates of specialists, thanks to do-it-yourself assembly.



### Einfache Installation easy installation

Gut, wenn man Werkzeug hat – aber für IP44.DE connect braucht man lediglich zwei Hände.

Tools are a good thing, but you only need two hands for IP44.DE connect.

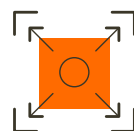

### Flexible Erweiterbarkeit flexible extensibility

Ein IP44.DE connect-System reicht so weit, wie Phantasie (und Garten) reichen.

An IP44.DE connect system extends as far as your imagination (and garden) goes.



### Volle Energie full of energy

Als 230 Volt-System benötigt IP44.DE connect weder Trafo noch aufwändige Vorschalttechnik.

IP44.DE connect is a 230 volt system that needs neither transformers nor complicated ballast technology.



### Intelligente Steuerung smart control

Per App und Controller lässt sich das System konfigurieren und über Smartphone oder Tablet steuern.

The system can be configured by app and controller and controlled from a smartphone or tablet.





Dank Hochvoltspannung lassen sich auch längere Leitungen verlegen – ganz ohne Trafos und Spannungsverluste.

The high voltage rating also allows for longer leads, without transformers and voltage loss.

## Große Freiheit Great freedom

So unterschiedlich wie Gärten und Balkone, so vielfältig sind auch die Beleuchtungsaufgaben, die es im Außenbereich zu lösen gilt. Das Schöne: IP44.DE connect ist für all diese Aufgaben wie geschaffen. Ganz ohne Erdarbeiten lassen sich unterschiedlichste Lichtpunkte setzen. Und weil unser System oberirdisch verlegt wird, lassen sich Lichtszenarien jederzeit verändern, ohne dass Fachhandwerker oder Baugerät anrücken müssten. IP44.DE connect steht also für die große Freiheit in der Außenbeleuchtung – bei erfreulich überschaubarem Aufwand.

Gardens and balconies can differ greatly. The same can also be said of the many diverse lighting tasks to be solved in the outside setting. Fortunately, IP44.DE connect is tailor-made for all these tasks. Many different light accents can be set without any need for earthworks. And the fact that the system is laid above ground means that light settings can be changed at any time without having to call in specialists or use construction machinery. And so IP44.DE connect offers great freedom for outside lighting, at pleasingly low cost.

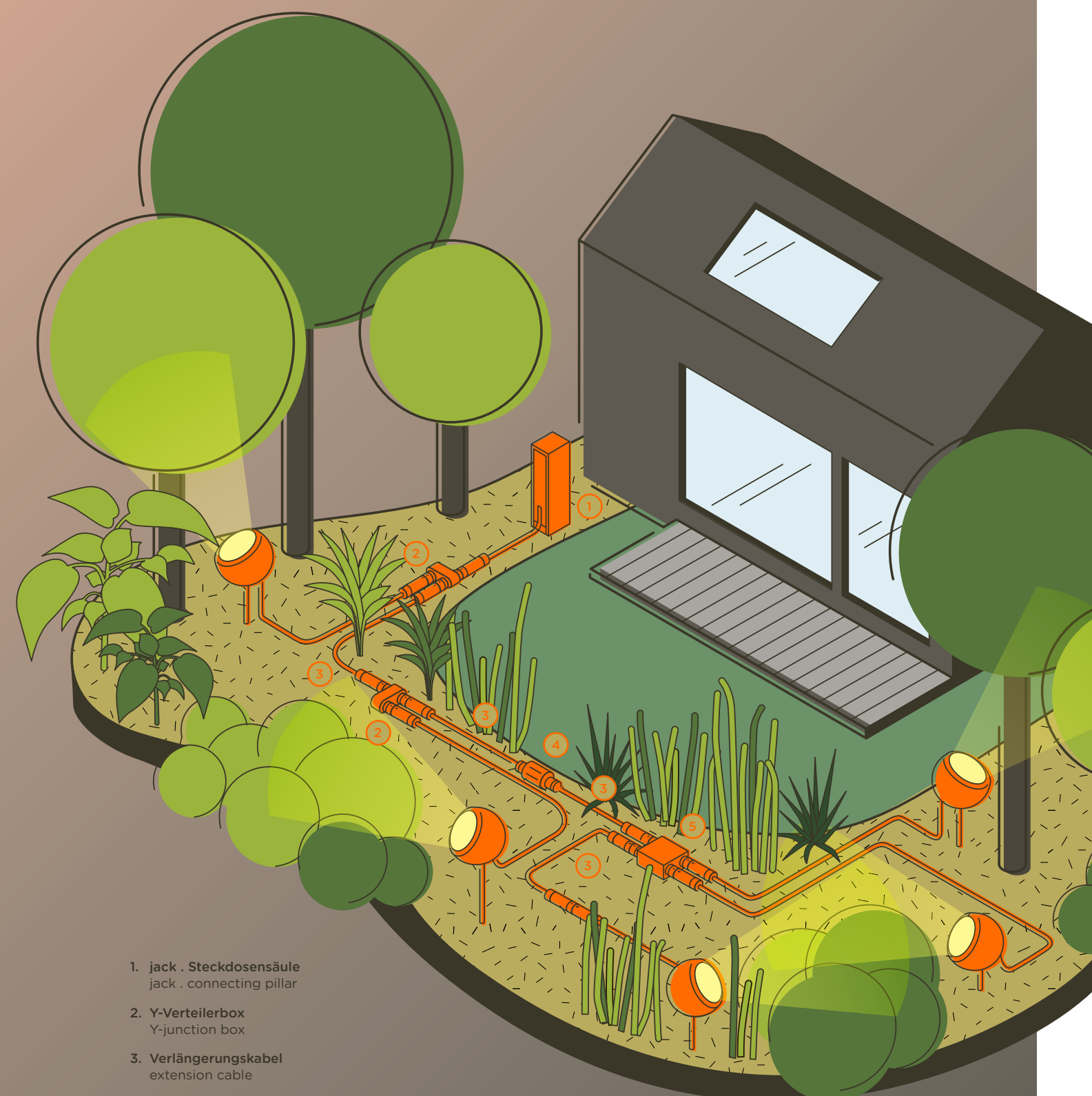

1. jack . Steckdosensäule  
jack . connecting pillar
2. Y-Verteilerbox  
Y-junction box
3. Verlängerungskabel  
extension cable
4. Controller (optional)  
controller (optional)
5. H-Verteilerbox  
H-junction box

# Vielfältig vernetzbar

## Versatile connectivity

Steckdose, Steckdosensäule oder Erdkabel? Bei der Vernetzung von IP44.DE connect gibt es für jedes Projekt den passenden Anschluss.  
Electrical socket, connecting pillar or underground cable? When it comes to connecting IP44.DE connect, we have the right solution for every project.

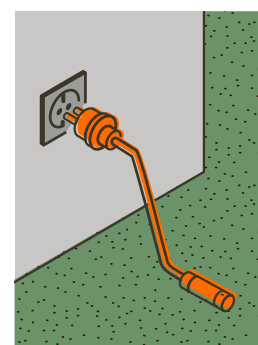

### 1. Energie aus der Steckdose energy from the electrical socket

Der schnellste Weg zum Licht im Garten oder auf dem Balkon: Einfach die Netz-Anschluss-Verbindung in die Steckdose stecken, beliebig viele Leuchten kombinieren – und fertig.

The fastest way to have light in the garden or on the balcony: simply plug the mains connection port into the electrical socket, combine as many luminaires as you want, and you're ready.

### 2. Netz-Anschluss über Steckdosensäule mains connection via connecting pillar

Über ein Erdkabel wird unkompliziert die Steckdosensäule jack mit Strom versorgt. Einfach Netz-Anschlussverbindung einstecken und Licht einschalten!

An underground cable is the straightforward way of supplying power to the connecting pillar jack. Simply plug in the mains connection port and switch the light on!

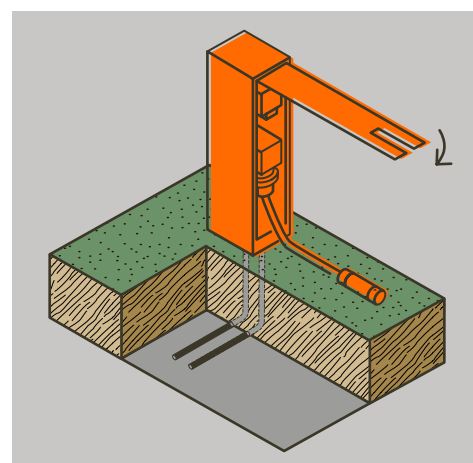

### 3. Einspeisung per Erd-Anschluss-Kit power feed with the underground connection kit

Die unauffälligste Art, ein IP44.DE connect-System netzseitig anzubinden: Über eine im Erd-Anschluss-Kit enthaltene Gießharzmuffe wird das System mit dem Erdkabel verbunden. Die Gießharzmuffe ist IP68 Schutzklassen-zertifiziert, korrosionsresistent und gewährleistet so über viele Jahre einen sicheren Anschluss ans Stromnetz.

The least conspicuous way to connect an IP44.DE connect system with the mains: the underground connection kit includes a cast resin sleeve to connect the system with the underground cable. The cast resin sleeve is certified to protection rating IP68 and is corrosion-resistant, thus warranting a reliable connection to the power supply that will last for many years.

# Robuste Verbindung

## Robust connection

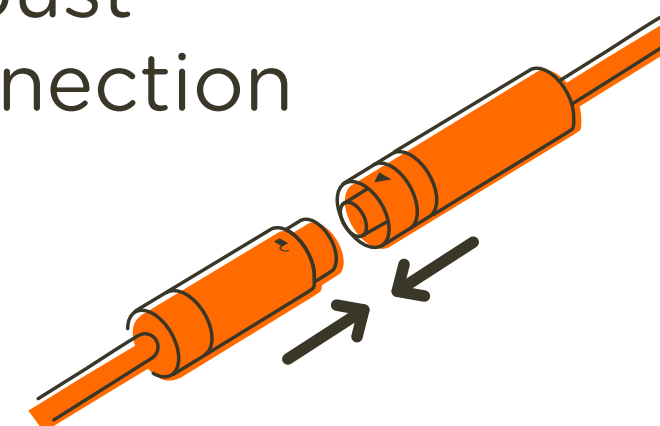

IP44.DE connect lässt sich eigenhändig installieren – keine Handwerkerunterstützung erforderlich!  
IP44.DE connect can be installed single-handed: no need for the help of a craftsman!

Im Außenbereich kommt es mehr als anderswo auf solide Verbindungen an, denen Wind und Wetter nichts anhaben können. Unser robustes TWISTLOCK-System kombiniert diese Hart-im-Nehmen-Qualitäten mit einem kinderleichten Stecksystem, das beim Verriegeln gleich Rückmeldung über die korrekte Endstellung gibt und somit Verlegefehler vermeidet.

Und so geht's: Durch den intelligenten TWISTLOCK-Mechanismus verrasten die Steckverbinder beim Zusammensetzen automatisch. Ein „Klick“-Geräusch verrät dem Nutzer, dass sich die Stecker sicher in der vorgesehenen Endstellung befinden. Soll das System verändert oder erweitert werden, lässt sich die Verbindung durch eine leichte Drehung wieder lösen.

Outside applications depend more than elsewhere on robust connections that are not affected by wind and weather. Our robust TWISTLOCK system combines these tough, resilient qualities with a foolproof plug-and-play system: once locked, it gives immediate feedback about the correct final position, thus avoiding installation errors.

This is how it works: the intelligent TWISTLOCK mechanism ensures the connectors lock automatically when they are put together. An audible click tells the user that the connectors are safely in the intended final position. A simple twist disconnects the elements again to change or extend the system.

### Einfaches Verbinden easy connection

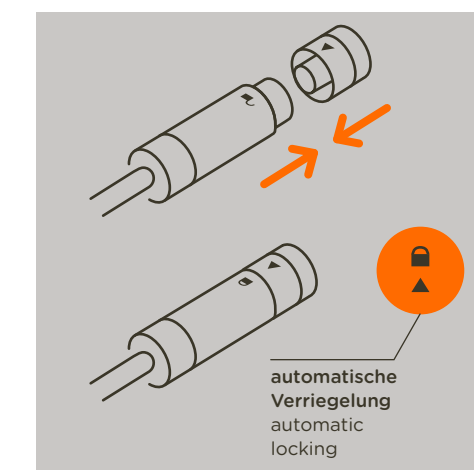

### Unkompliziertes Umbauen uncomplicated modification

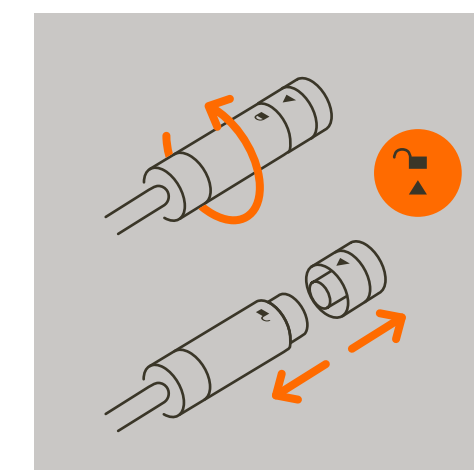



Spart Zeit und Mühe: Steckverbinder werden einfach und sicher verrastet.

Saves time and effort: connectors lock easily and safely.

# Komponenten und Zubehör

## Components and accessories



### 1. Netz-Anschlussverbindung mains connection port

Für den sicheren Anschluss ans Netz.  
Wahlweise zum Anschluss an eine  
Steckdose oder Steckdosensäule.

For a reliable connection to the mains.  
Can be connected to an electrical socket  
or connecting pillar.



### 2. Steckdosensäule jack connecting pillar jack

Die Alternative zum Erd- und Steckdosenanschluss: Oberirdische Zweifachsteckdose mit Erd-Anschluss-Anbindung.

The alternative to the underground connection and electrical socket: above-ground double socket with underground connection.

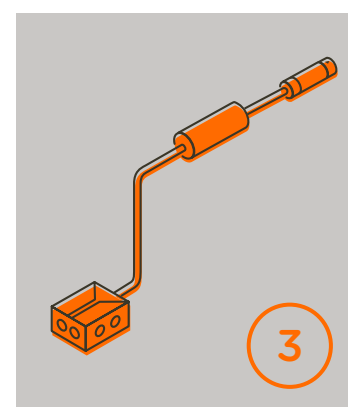

### 3. Erd-Anschluss-Kit underground connection kit

Verbindet das IP44.DE  
connect-System unauf-  
fällig und störungssicher  
mit dem Stromnetz.

Provides the IP44.DE  
connect system with  
an inconspicuous, trouble-  
free connection to the  
mains.



### 4. + 5. Y- und H-Verteilerbox Y- and H-junction box

Vernetzt 2 oder 3 Leuchten mit dem System – und  
ermöglicht die Bildung von Leuchtengruppen, die sich  
über den Controller (8.) gemeinsam ansteuern lassen.

Connects 2 or 3 luminaires with the system and  
can be used to set up luminaire groups that are controlled  
together by the same controller (8.).

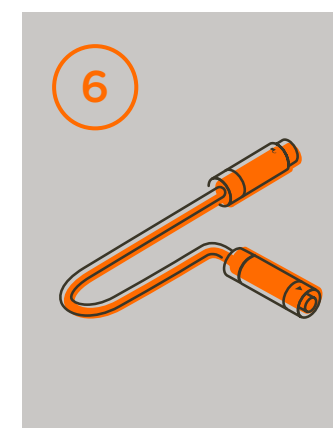

### 6. Verlängerungskabel extension cable

Wahlweise in 2, 5 oder  
10 Metern Länge zu haben  
– je nachdem, wie weit das  
System reichen soll.

Either 2, 5 or 10 metres  
in length, depending on  
the required range of the  
system.

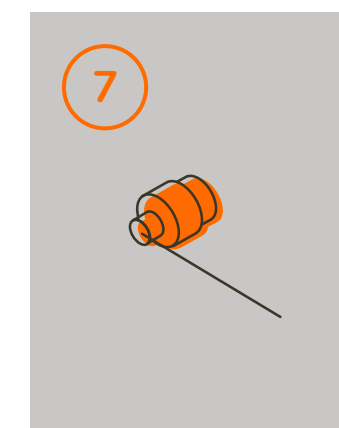

### 7. Verschlusskappe Buchse sealing cap socket

Verschließt unbenutzte  
Buchsen.

Seals sockets that  
are not in use.

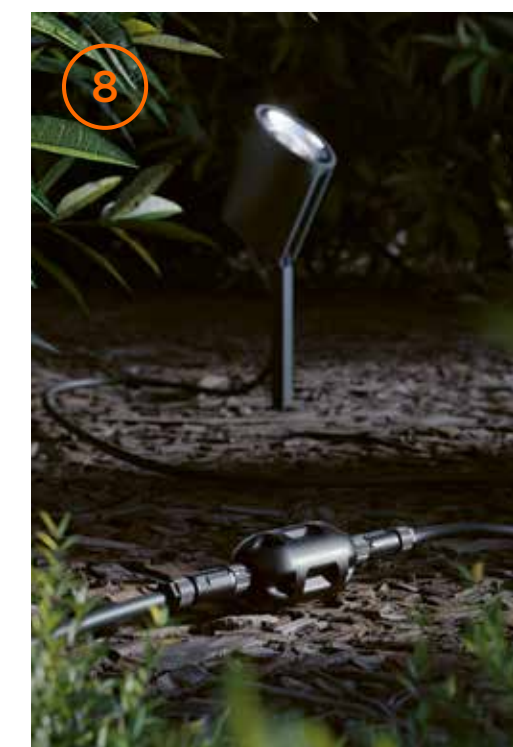

### 8. Controller controller

Über die kostenlose Casambi-App und  
Bluetooth Low Energy angesteuert, akti-  
viert und dimmt der Controller einzelne  
Leuchten oder vernetzte Leuchtengruppen.

The controller works via the free Casambi  
app and Bluetooth Low Energy to activate  
and dim individual luminaires or connected  
luminaire groups.



# Intelligent inszeniert

## Smart setting



Die Casambi-App gibt es zum kostenlosen Download im App/Play Store.

The Casambi app is available as a free download in the app/play store.



Schalten + Dimmen  
switching + dimming



Ansteuern von Einzelleuchten oder Leuchtengruppen  
actuating individual luminaires or groups of luminaires



Anwesenheit simulieren  
simulating presence



Lichtszenen speichern + abspielen  
saving + playing light scenes



Timersteuerung  
timer control

Nur die smarten kommen in den Garten: Mit der kostenlosen Casambi-App lassen sich alle IP44.DE connect-Leuchten komfortabel per Smartphone oder Tablet steuern – und zwar sowohl einzelne Leuchten wie auch ganze Leuchtengruppen. Dafür wird der Controller ganz einfach über die Casambi-App – gibt es für iOS und Android – und Bluetooth Low Energy angesteuert und vor die jeweilige Lichtquelle gesteckt.

Mit einem Controller lassen sich sowohl einzelne Leuchten als auch ganze Leuchtengruppen steuern. Werden mehrere Controller angeschlossen, bildet sich ein durchgehendes Mesh-Netzwerk. Auf diese Weise sind bis zu 30 Meter Abstand von Controller zu Controller möglich – und damit eine Reichweite, auf die es im Außenbereich häufig ankommt. Mit IP44.DE connect lässt sich Außenlicht nicht nur auf Entfernung, sondern auch intelligent konfigurieren – und jederzeit flexibel neu kombinieren.

Smart gardens: the free Casambi app can be used for convenient control of all IP44.DE connect luminaires from your smartphone or tablet, either as individual luminaires or in whole luminaire groups. The Casambi app is available for iOS and Android, and works with Bluetooth Low Energy for simple actuation of the controller, which is positioned in front of the respective light source.

One controller can be used to control both individual luminaires and also whole luminaire groups. Several connectors can be connected up to produce a continuous mesh network. As a result, it is possible to have distances of up to 30 metres between the controllers, thus facilitating a range that is frequently required in outside contexts. IP44.DE connect permits remote, smart configuration of outdoor lighting while offering flexible scope for new combinations at any time.

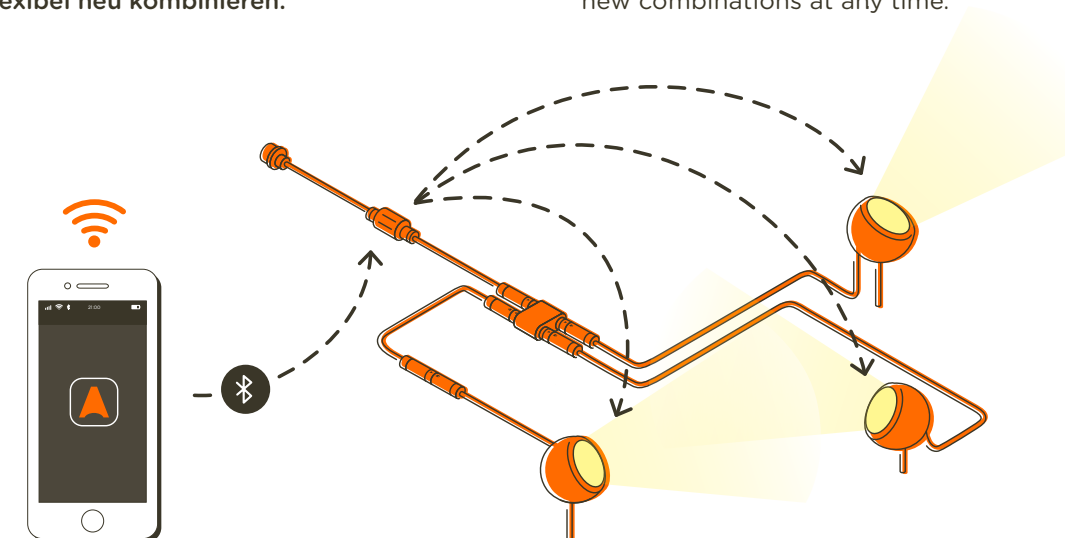



# IP44.DE connect Leuchten luminaires

Farbe colour      Art.-Nr. item no.      Systemleistung system performance

Anschluss: 5 m Zuleitung (H05RN8-F 3G0,75 mm<sup>2</sup>) inkl. connect Stecker  
 5 m Zuleitung auf Anfrage kürzbar  
 connection: 5 m supply cable (H05RN8-F 3G0,75 mm<sup>2</sup>) incl. connect plug  
 5 m supply cable can be shortened on request

## piek connect

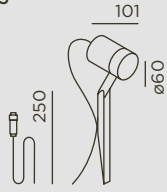
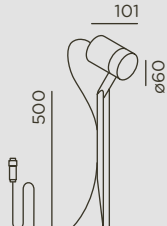
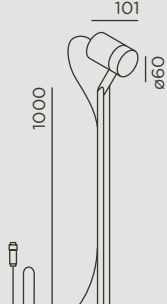
| Modell  | Farbe               | Art.-Nr.       | Systemleistung |
|---|---------------------|----------------|----------------|
| piek 25<br>    | anthracite RAL 7016 | 92071-27-AN-CO | 6 W/220 lm     |
|   | cool brown          | 92071-27-CB-CO | 6 W/220 lm     |
|   | deep black RAL 9005 | 92071-27-BL-CO | 6 W/220 lm     |
| piek 50<br>    | anthracite RAL 7016 | 92070-27-AN-CO | 6 W/220 lm     |
|   | cool brown          | 92070-27-CB-CO | 6 W/220 lm     |
|   | deep black RAL 9005 | 92070-27-BL-CO | 6 W/220 lm     |
| piek 100<br> | anthracite RAL 7016 | 92072-27-AN-CO | 6 W/220 lm     |
|   | cool brown          | 92072-27-CB-CO | 6 W/220 lm     |
|   | deep black RAL 9005 | 92072-27-BL-CO | 6 W/220 lm     |

+ Produktdetails Seite 268 product details page 268

Anschluss: 5 m Zuleitung (H05RN8-F 3G0,75 mm<sup>2</sup>) inkl. connect Stecker  
 5 m Zuleitung auf Anfrage kürzbar  
 connection: 5 m supply cable (H05RN8-F 3G0,75 mm<sup>2</sup>) incl. connect plug  
 5 m supply cable can be shortened on request

## piek lettura connect

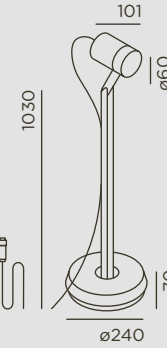
| Modell  | Farbe               | Art.-Nr.       | Systemleistung |
|---|---------------------|----------------|----------------|
| piek lettura connect<br> | anthracite RAL 7016 | 92075-27-AN-CO | 6 W/220 lm     |
|   | cool brown          | 92075-27-CB-CO | 6 W/220 lm     |
|   | deep black RAL 9005 | 92075-27-BL-CO | 6 W/220 lm     |

+ Produktdetails Seite 276 product details page 276

Preise in separater Preisliste price in separate price list + [www.IP44.de](http://www.IP44.de)

| Farbe<br>colour  | Art.-Nr.<br>item no. | Systemleistung<br>system performance |
|--|----------------------|--------------------------------------|
| Anschluss: 5 m Zuleitung (H05RN-F 3G0,75 mm <sup>2</sup> ) inkl. connect Stecker<br>5 m Zuleitung auf Anfrage kürzbar<br>connection: 5 m supply cable (H05RN-F 3G0,75 mm <sup>2</sup> ) incl. connect plug<br>5 m supply cable can be shortened on request |                      |                                      |

## lin base connect

| lin 40 base | Farbe<br>colour        | Art.-Nr.<br>item no. | Systemleistung<br>system performance |
|-------------|------------------------|----------------------|--------------------------------------|
|             | anthracite<br>RAL 7016 | 92093-27-AN-CO       | 9 W/164 lm                           |
|             | cool brown             | 92093-27-CB-CO       | 9 W/164 lm                           |
|             | deep black<br>RAL 9005 | 92093-27-BL-CO       | 9 W/164 lm                           |

| lin 70 base | Farbe<br>colour        | Art.-Nr.<br>item no. | Systemleistung<br>system performance |
|-------------|------------------------|----------------------|--------------------------------------|
|             | anthracite<br>RAL 7016 | 92090-27-AN-CO       | 18 W/328 lm                          |
|             | cool brown             | 92090-27-CB-CO       | 18 W/328 lm                          |
|             | deep black<br>RAL 9005 | 92090-27-BL-CO       | 18 W/328 lm                          |

+ Produktdetails Seite 242 product details page 242

| lin spike connect  | Farbe<br>colour | Art.-Nr.<br>item no. | Systemleistung<br>system performance |
|--|-----------------|----------------------|--------------------------------------|
| Anschluss: 5 m Zuleitung (H05RN-F 3G0,75 mm <sup>2</sup> ) inkl. connect Stecker<br>5 m Zuleitung auf Anfrage kürzbar<br>connection: 5 m supply cable (H05RN-F 3G0,75 mm <sup>2</sup> ) incl. connect plug<br>5 m supply cable can be shortened on request |                 |                      |                                      |

| lin 40 spike | Farbe<br>colour        | Art.-Nr.<br>item no. | Systemleistung<br>system performance |
|--------------|------------------------|----------------------|--------------------------------------|
|              | anthracite<br>RAL 7016 | 92094-27-AN-CO       | 9 W/164 lm                           |
|              | cool brown             | 92094-27-CB-CO       | 9 W/164 lm                           |
|              | deep black<br>RAL 9005 | 92094-27-BL-CO       | 9 W/164 lm                           |

| lin 70 spike | Farbe<br>colour        | Art.-Nr.<br>item no. | Systemleistung<br>system performance |
|--------------|------------------------|----------------------|--------------------------------------|
|              | anthracite<br>RAL 7016 | 92091-27-AN-CO       | 18 W/328 lm                          |
|              | cool brown             | 92091-27-CB-CO       | 18 W/328 lm                          |
|              | deep black<br>RAL 9005 | 92091-27-BL-CO       | 18 W/328 lm                          |

Größe in mm  
size in mm + Produktdetails Seite 248 product details page 248

Preise in separater Preisliste prices in separate price list + [www.IP44.de](http://www.IP44.de)

| Farbe<br>colour  | Art.-Nr.<br>item no. | Systemleistung<br>system performance |
|--|----------------------|--------------------------------------|
| Anschluss: 5 m Zuleitung (H05RN8-F 3G0,75 mm <sup>2</sup> ) inkl. connect Stecker<br>5 m Zuleitung auf Anfrage kürzbar<br>connection: 5 m supply cable (H05RN8-F 3G0,75 mm <sup>2</sup> ) incl. connect plug<br>5 m supply cable can be shortened on request |                      |                                      |

## pad connect

| pad connect | Farbe<br>colour        | Art.-Nr.<br>item no. | Systemleistung<br>system performance |
|-------------|------------------------|----------------------|--------------------------------------|
|             | anthracite<br>RAL 7016 | 91065-27-AN-CO       | 8 W/553 lm                           |
|             | cool brown             | 91065-27-CB-CO       | 8 W/553 lm                           |
|             | deep black<br>RAL 9005 | 91065-27-BL-CO       | 8 W/553 lm                           |

+ Produktdetails Seite 262 product details page 262

| slat spike connect   | Farbe<br>colour | Art.-Nr.<br>item no. | Systemleistung<br>system performance |
|--|-----------------|----------------------|--------------------------------------|
| Anschluss: 5 m Zuleitung (H05RN8-F 3G0,75 mm <sup>2</sup> ) inkl. connect Stecker<br>5 m Zuleitung auf Anfrage kürzbar<br>connection: 5 m supply cable (H05RN8-F 3G0,75 mm <sup>2</sup> ) incl. connect plug<br>5 m supply cable can be shortened on request |                 |                      |                                      |

| slat spike connect | Farbe<br>colour        | Art.-Nr.<br>item no. | Systemleistung<br>system performance |
|--------------------|------------------------|----------------------|--------------------------------------|
|                    | anthracite<br>RAL 7016 | 91030-27-AN-CO       | 8 W/280 lm                           |
|                    | cool brown             | 91030-27-CB-CO       | 8 W/280 lm                           |
|                    | deep black<br>RAL 9005 | 91030-27-BL-CO       | 8 W/280 lm                           |

+ Produktdetails Seite 302 product details page 302









| stic spike connect   | Farbe<br>colour | Art.-Nr.<br>item no. | Systemleistung<br>system performance |
|--|-----------------|----------------------|--------------------------------------|
| Anschluss: 5 m Zuleitung (H05RN8-F 3G0,75 mm <sup>2</sup> ) inkl. connect Stecker<br>5 m Zuleitung auf Anfrage kürzbar<br>connection: 5 m supply cable (H05RN8-F 3G0,75 mm <sup>2</sup> ) incl. connect plug<br>5 m supply cable can be shortened on request |                 |                      |                                      |

| stic 30 spike | Farbe<br>colour        | Art.-Nr.<br>item no. | Systemleistung<br>system performance |
|---------------|------------------------|----------------------|--------------------------------------|
|               | anthracite<br>RAL 7016 | 91061-27-AN-CO       | 8 W/559 lm                           |
|               | cool brown             | 91061-27-CB-CO       | 8 W/559 lm                           |
|               | deep black<br>RAL 9005 | 91061-27-BL-CO       | 8 W/559 lm                           |

| stic 70 spike | Farbe<br>colour        | Art.-Nr.<br>item no. | Systemleistung<br>system performance |
|---------------|------------------------|----------------------|--------------------------------------|
|               | anthracite<br>RAL 7016 | 91060-27-AN-CO       | 8 W/559 lm                           |
|               | cool brown             | 91060-27-CB-CO       | 8 W/559 lm                           |
|               | deep black<br>RAL 9005 | 91060-27-BL-CO       | 8 W/559 lm                           |

Größe in mm  
size in mm + Produktdetails Seite 310 product details page 310

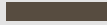
Preise in separater Preisliste price in separate price list + [www.IP44.de](http://www.IP44.de)





|  | Farbe<br>colour  | Art.-Nr.<br>item no. | Systemleistung<br>system performance |
|--|--|----------------------|--------------------------------------|
| <b>shot connect</b>  |  |                      |                                      |
| Anschluss: 5 m Zuleitung (H05RN8-F 3G0,75 mm <sup>2</sup> ) inkl. connect Stecker<br>5 m Zuleitung auf Anfrage kürzbar<br>connection: 5 m supply cable (H05RN8-F 3G0,75 mm <sup>2</sup> ) incl. connect plug<br>5 m supply cable can be shortened on request |  |                      |                                      |
| shot 4 W<br>  |  anthracite<br>RAL 7016 | 91090-27-4W-AN-CO    | 4 W/219 lm                           |
|  |  cool brown             | 91090-27-4W-CB-CO    | 4 W/219 lm                           |
|  |  deep black<br>RAL 9005 | 91090-27-4W-BL-CO    | 4 W/219 lm                           |
| shot 15 W<br>   |  anthracite<br>RAL 7016 | 91090-27-15W-AN-CO   | 15 W/874 lm                          |
|  |  cool brown             | 91090-27-15W-CB-CO   | 15 W/874 lm                          |
|  |  deep black<br>RAL 9005 | 91090-27-15W-BL-CO   | 15 W/874 lm                          |
| + Produktdetails Seite 286 product details page 286  |  |                      |                                      |

## Erforderliches Zubehör required accessory

für festen Untergrund for solid ground

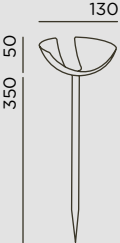
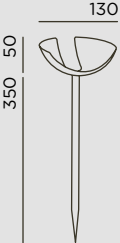



| shot ring<br> | Farbe<br>colour  | Art.-Nr.<br>item no. | Material<br>material   |
|--|--|----------------------|--|
|  |  anthracite<br>RAL 7016 | 91090-R-AN           | Aluminiumguss pulverbeschichtet<br>aluminium die-casting powder-coated |
|  |  cool brown             | 91090-R-CB           | Aluminiumguss pulverbeschichtet<br>aluminium die-casting powder-coated |
|  |  deep black<br>RAL 9005 | 91090-R-BL           | Aluminiumguss pulverbeschichtet<br>aluminium die-casting powder-coated |

für unbefestigte Beet- und Grünflächen for unpaved beds and greens

| shot tee<br> | Farbe<br>colour  | Art.-Nr.<br>item no. | Material<br>material   |
|---|--|----------------------|--|
|              |  anthracite<br>RAL 7016 | 91091-AN             | Schale: Aluminiumguss pulverbeschichtet<br>Stab: Edelstahl pulverbeschichtet<br>bowl: aluminium die-casting powder-coated<br>pole: stainless steel powder-coated |
|   |  cool brown             | 91091-CB             | Schale: Aluminiumguss pulverbeschichtet<br>Stab: Edelstahl pulverbeschichtet<br>bowl: aluminium die-casting powder-coated<br>pole: stainless steel powder-coated |
|   |  deep black<br>RAL 9005 | 91091-BL             | Schale: Aluminiumguss pulverbeschichtet<br>Stab: Edelstahl pulverbeschichtet<br>bowl: aluminium die-casting powder-coated<br>pole: stainless steel powder-coated |

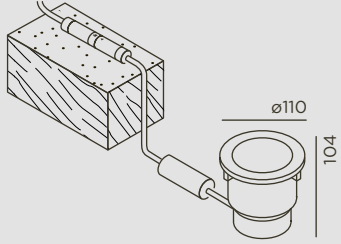
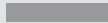
Größe in mm  
size in mm

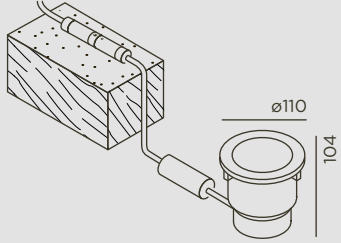
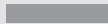
Preise in separater Preisliste prices in separate price list + [www.IP44.de](http://www.IP44.de)

|  | Farbe<br>colour   | Art.-Nr.<br>item no. | Systemleistung<br>system performance |
|--|---|----------------------|--------------------------------------|
| <b>in A + in S connect</b>   |   |                      |                                      |
| Anschluss: 2 m Zuleitung (H05RN8-F 3G0,75 mm <sup>2</sup> ) mit Aquastop; inkl. connect Stecker<br>connection: 2 m supply cable (H05RN8-F 3G0,75 mm <sup>2</sup> ) with aquastop; incl. connect plug |   |                      |                                      |
| in A<br>  |  stainless steel<br>Sicherheits-<br>glas klar<br>safety glass clear  | 91081-27-CO          | 8 W/ 539 lm                          |
|  |  stainless steel<br>black<br>galvanisiert<br>Sicherheitsglas<br>getönt<br>galvanized<br>safety glass<br>tinted | 91081-27-BL-CO       | 8 W/238 lm                           |
| + Produktdetails Seite 238 product details page 238  |   |                      |                                      |
| in S<br>  |  stainless steel<br>Sicherheitsglas<br>klar<br>safety glass clear  | 91080-27-CO          | 8 W/574 lm                           |
|  |  stainless steel<br>black<br>galvanisiert<br>Sicherheitsglas<br>getönt<br>galvanized<br>safety glass<br>tinted | 91080-27-BL-CO       | 8 W/261 lm                           |
| + Produktdetails Seite 240 product details page 240  |   |                      |                                      |

Preise in separater Preisliste price in separate price list + [www.IP44.de](http://www.IP44.de)

# IP44.DE connect Zubehör accessory

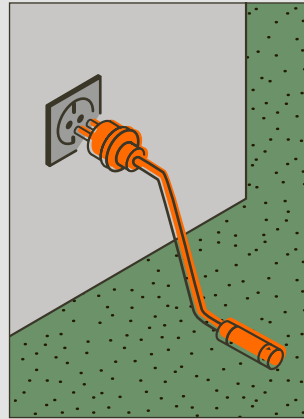

**Netz-Anschlussverbindung**  
mains connection port

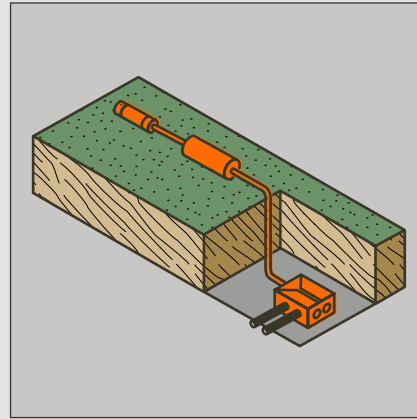

**Erd-Anschluss-Kit**  
underground connection kit

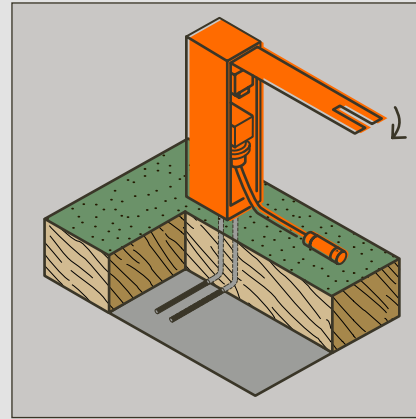



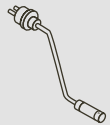
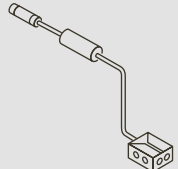
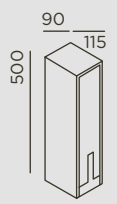

**jack . Steckdosensäule**  
jack . connecting pillar

| Zubehör<br>accessory  | Artikel<br>article   | Art.-Nr.<br>item no.   |
|---|--|--|
|    | <b>5 m Netz-Anschlussverbindung</b><br>5 m mains connection port<br><br><b>Schutzkontaktstecker auf connect Buchse</b><br>Kabel: H07RN-F 3G1,5 mm <sup>2</sup><br>Schutzart: IP44<br>safety plug on connect socket<br>cable: H07RN-F 3G1,5 mm <sup>2</sup><br>protection class: IP44   | 55100  |
|  | <b>Erd-Anschluss-Kit</b><br>underground connection kit<br><br><b>2 m Anschlussverbindung mit connect Buchse, Aquastop und offenem Kabelende</b><br>Erdkabel: H05RN8-F 3G0,75 mm <sup>2</sup><br><br><b>Erd-Abzweigkasten inkl. Anschlussklemme + Gießharz:</b><br>Installation: 7x Kabeleinführung;<br>Anschlussklemme 5x 2,5 mm <sup>2</sup><br>Schutzart: IP65<br>2 m connection port with connect socket, aquastop and open cable end<br>underground cable: H05RN8-F 3G0,75 mm <sup>2</sup><br><br>earth distribution box incl. connection terminal+cast resin:<br>installation: 7x cable entry point;<br>connection terminal 5x 2,5 mm <sup>2</sup><br>protection class: IP65  | 55202  |
|  | <b>jack . Steckdosensäule</b><br>jack . connecting pillar<br><br>inkl. 2x Schutzkontaktsteckdosen<br>(belgische-/französische + Schweizer Norm möglich)<br>Installation: Anschlussklemme 5x 1,5 mm <sup>2</sup> ;<br>Durchgangsverdrahtung mit Y-Verbinder in der Säule möglich<br>Montage: Bauseitiges Fundament oder befestigter Untergrund<br>Material: Aluminiumguss pulverbeschichtet<br>Schutzart: IP54<br><br>incl. 2x safety sockets (Belgian/French + Swiss norm possible)<br>installation: connection terminal 5x 1,5 mm <sup>2</sup> ;<br>possibility of through wiring with Y-connector inside pillar<br>assembly: on site foundation or solid ground<br>material: aluminium die-casting powder-coated<br>protection class: IP54 | <b>EUR-norm</b><br>55090-AN<br>55090-CB<br>55090-BL<br><br><b>BE+FR-norm</b><br>55090-BEFR-AN<br>55090-BEFR-CB<br>55090-BEFR-BL<br><br><b>CH-norm</b><br>55090-CH-AN<br>55090-CH-CB<br>55090-CH-BL |

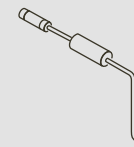
Größe in mm  
size in mm

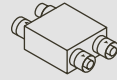
Preise in separater Preisliste . prices in separate price list + [www.IP44.de](http://www.IP44.de)

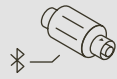
| Zubehör<br>accessory  | Artikel<br>article   | Art.-Nr.<br>item no.                 |
|---|--|--------------------------------------|
|    | <b>Erd-Anschlussverbindung</b><br>earth connection port<br><br><b>2 m Erd-Anschlussverbindung mit connect-Buchse, Aquastop und offenem Kabelende</b><br>Erdkabel: H05RN8-F 3G0,75 mm <sup>2</sup><br>Schutzart: IP65<br>2 m earth connection port with connect socket, aquastop and open cable end<br>underground cable: H05RN8-F 3G0,75 mm <sup>2</sup><br>protection class: IP65 | 55112                                |
|    | <b>Verlängerungskabel</b><br>extension cable<br><br><b>connect Stecker auf connect Buchse</b><br>Kabel: H07RN-F 3G1,5 mm <sup>2</sup><br>Schutzart: IP65<br>connect plug on connect socket<br>cable: H07RN-F 3G1,5 mm <sup>2</sup><br>protection class: IP65   | 2 m 55102<br>5 m 55105<br>10 m 55110 |
|   | <b>Sonderlängen auf Anfrage</b><br>special lengths on request  |                                      |
|  | <b>Y-Verteilerbox</b><br>Y-junction box<br><br><b>1x connect Stecker, 2x connect Buchse</b><br>Schutzart: IP65<br>1x connect plug, 2x connect socket<br>protection class: IP65   | 55122                                |
|  | <b>H-Verteilerbox</b><br>H-junction box<br><br><b>1x connect Stecker, 3x connect Buchse</b><br>Schutzart: IP65<br>1x connect plug, 3x connect socket<br>protection class: IP65   | 55123                                |
|  | <b>Verschlusskappe Buchse</b><br>sealing cap socket  | 55192                                |
|  | <b>Controller</b><br>controller<br><br>Kompatibilität: Casambi<br>Ein- und Ausgangsspannung: 230V<br>max. Ausgangsleistung: 150 W<br>Übertragungreichweite: 30 m (freies Gelände)<br>Schutzart: IP65<br>compatibility: Casambi<br>in- and output voltage: 230V<br>max. output power: 150 W<br>transmission range: 30 m (free area)<br>protection class: IP65                       | 55400                                |

Preise in separater Preisliste . prices in separate price list + [www.IP44.de](http://www.IP44.de)