

# LITA

design David Dolcini

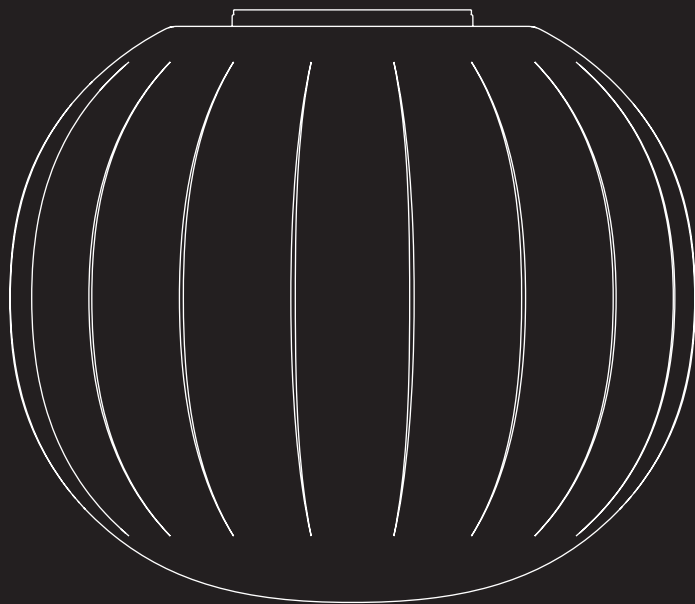

**LUCE  
PLAN**

D92



## D92P14

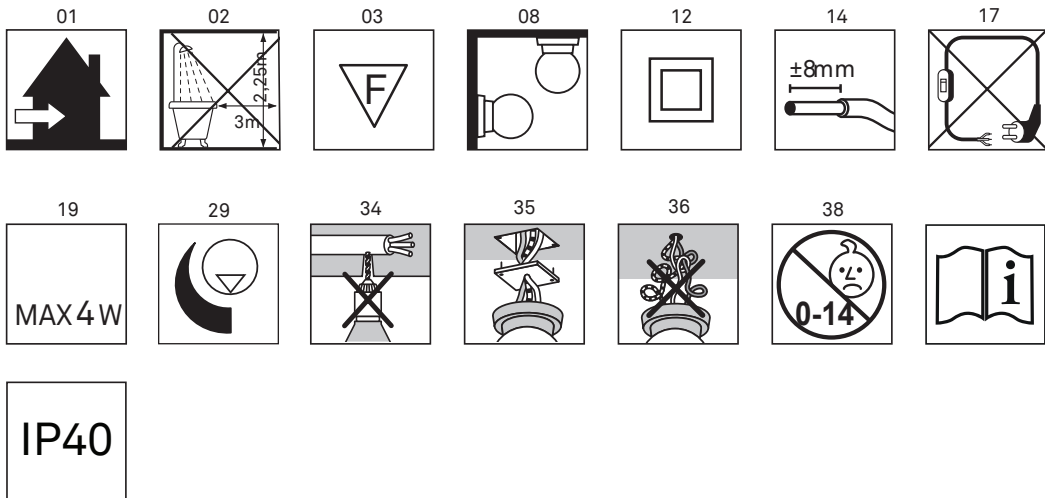

## D92P18

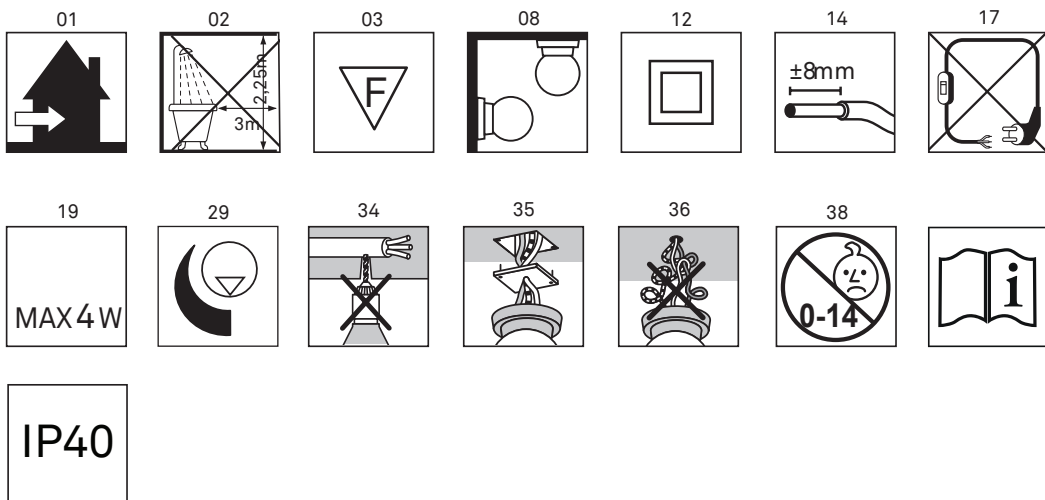

# D92P30

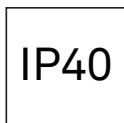
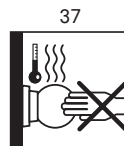
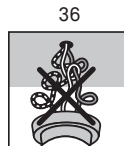
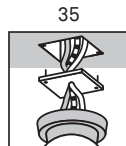
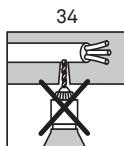
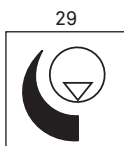
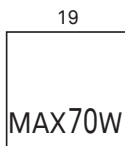
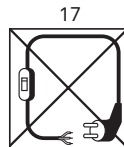
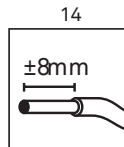
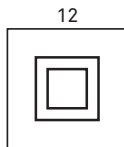
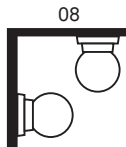
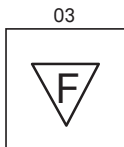
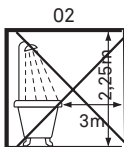
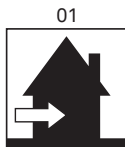

# D92P14

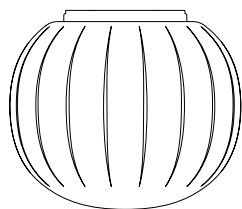

12 cm  
4.7"

14 cm

5.5"

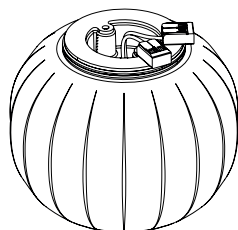

x1



a



b

IP40

kg 0,6 kg

lb 1.3 lb

# D92P18+D92/2

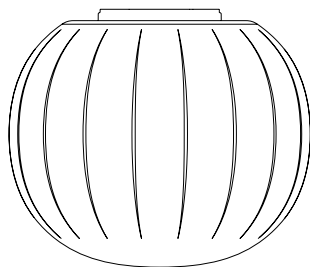

15 cm  
5.9"

18 cm

7"

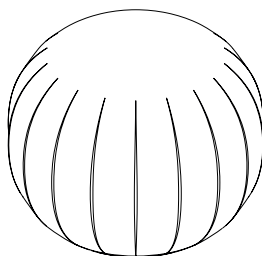

x1

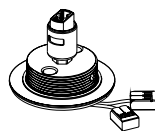

x1



a



b

kg 0,8 kg

lb 1.7 lb

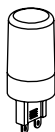

MAX  
4W  
LED  
G9

# D92P30+D92/3



a



b

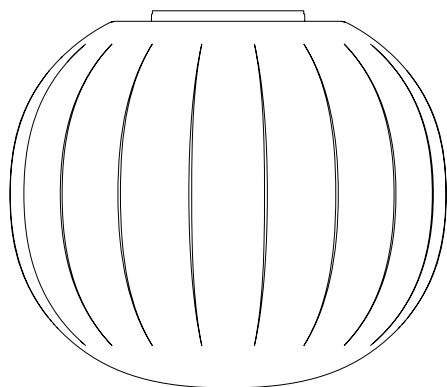

26 cm

10"

30 cm

11.8"

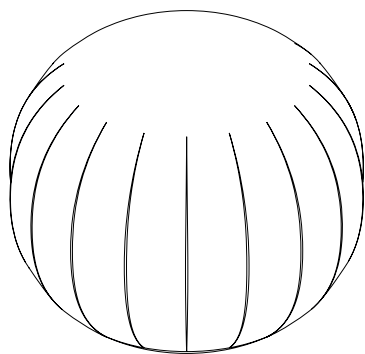

x1

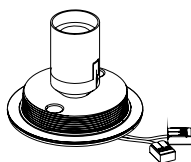

x1

kg 2,2 kg

lb 4.8 lb



MAX  
16W  
LED  
E27



MAX  
70W  
E27

## D92P14

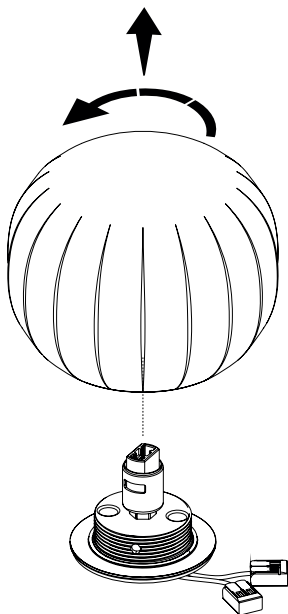

1

D92P14 - D92P18 - D92P30

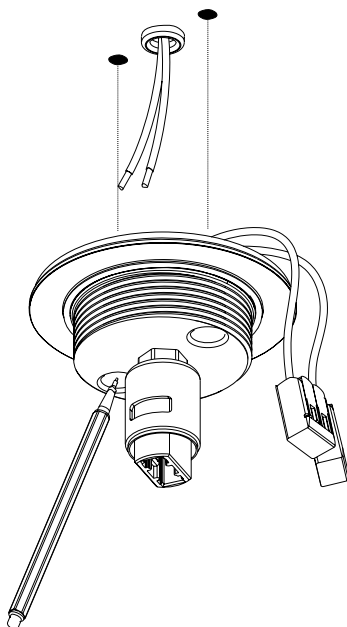

# 1.1

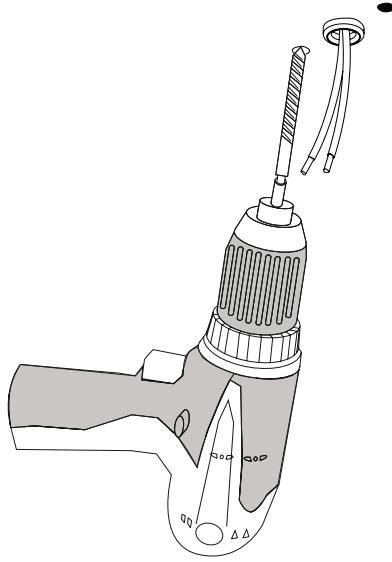
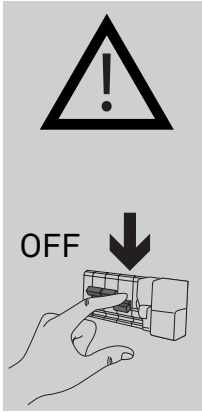

# 1.2

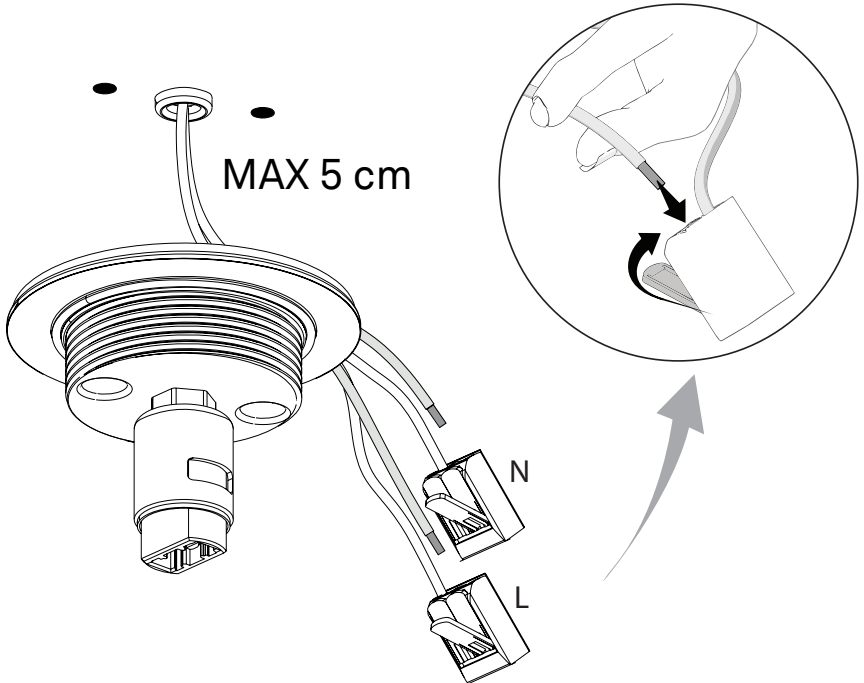

## 1.3

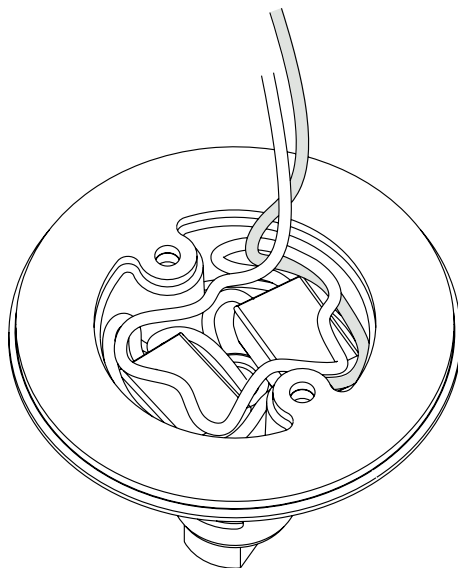

## 1.4

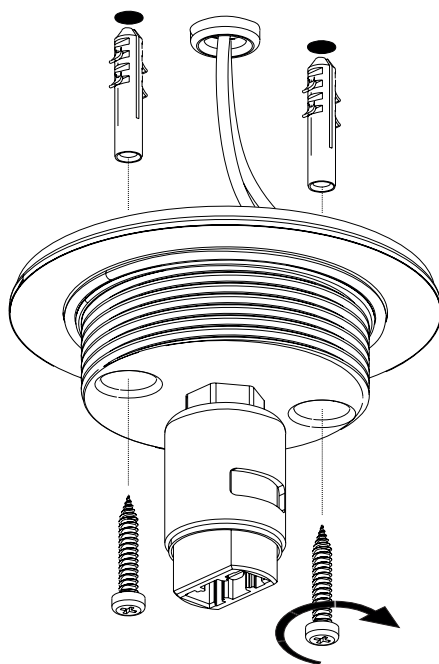



---

# 2

D92P14 - D92P18

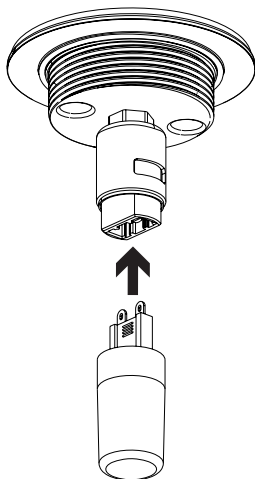

## D92P30

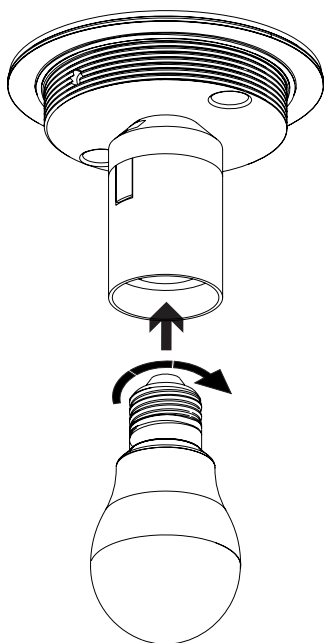

# 2.1 D92P14 - D92P18

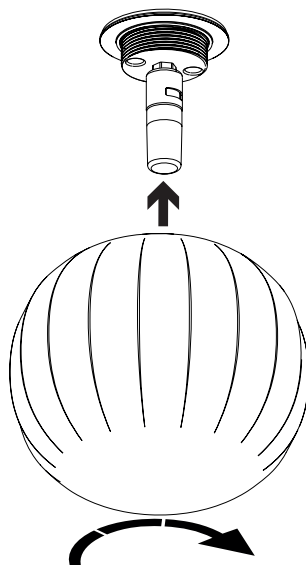

# D92P30

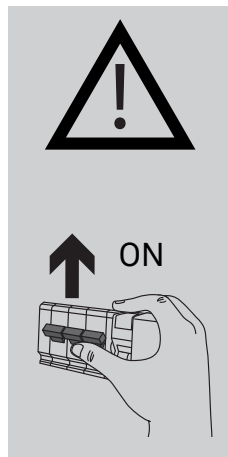
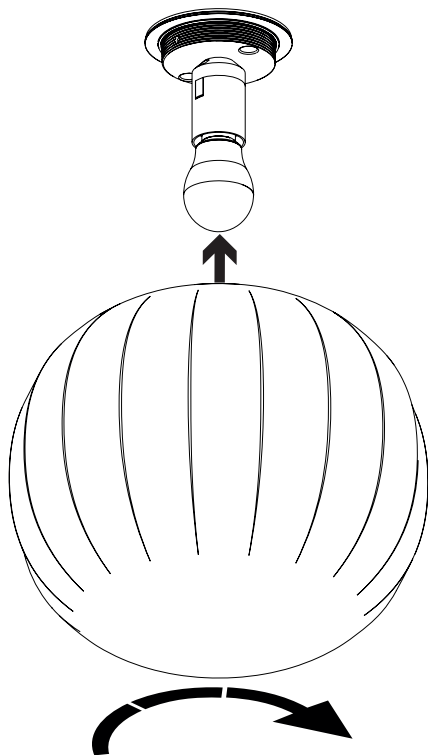

# 3

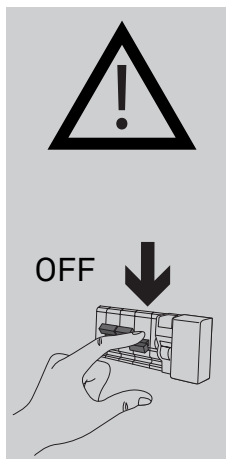

1.

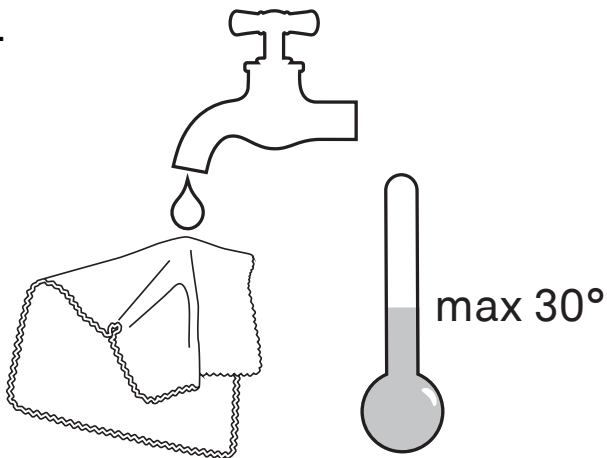

2.



3.

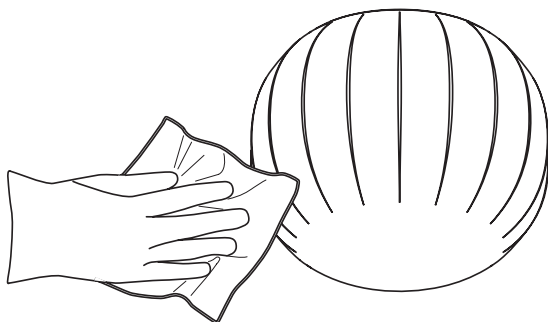



[www.luceplan.com](http://www.luceplan.com)

D920I0001