

LITA

design David Dolcini

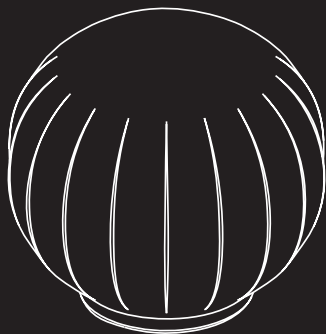
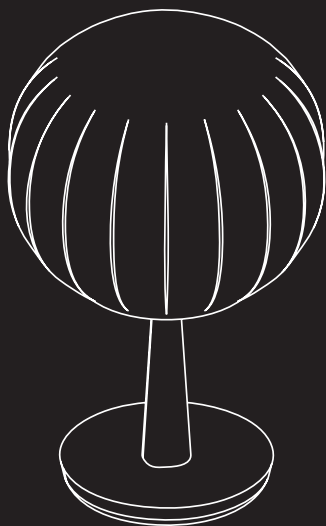

**LUCE
PLAN**

D92



D92V14

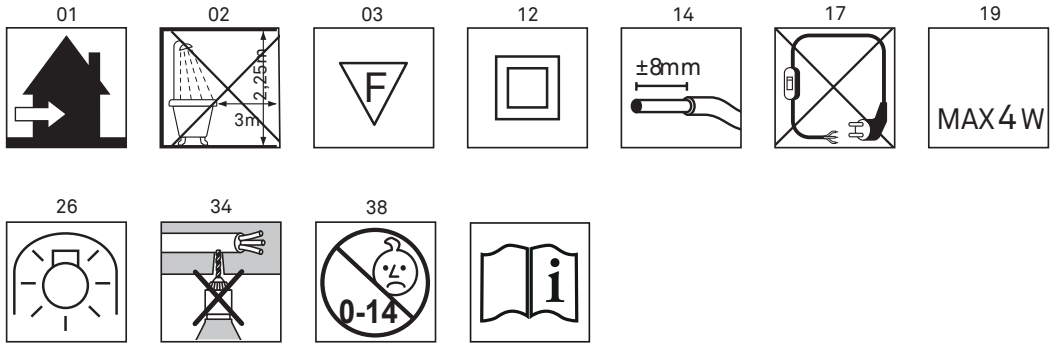

D92V18

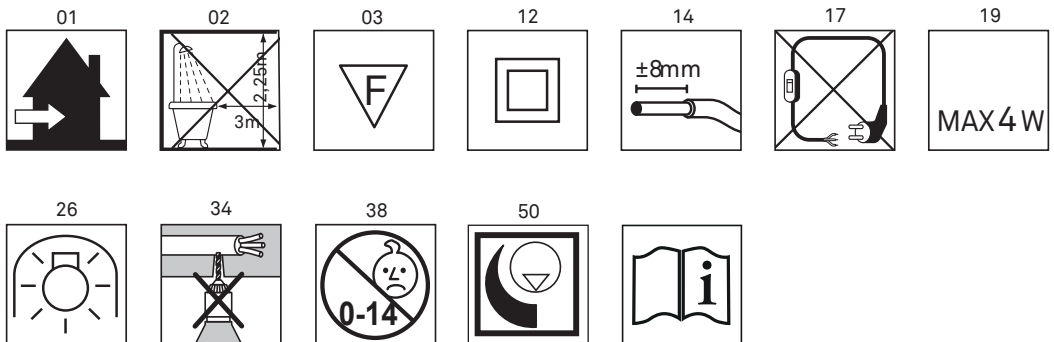

D92V30

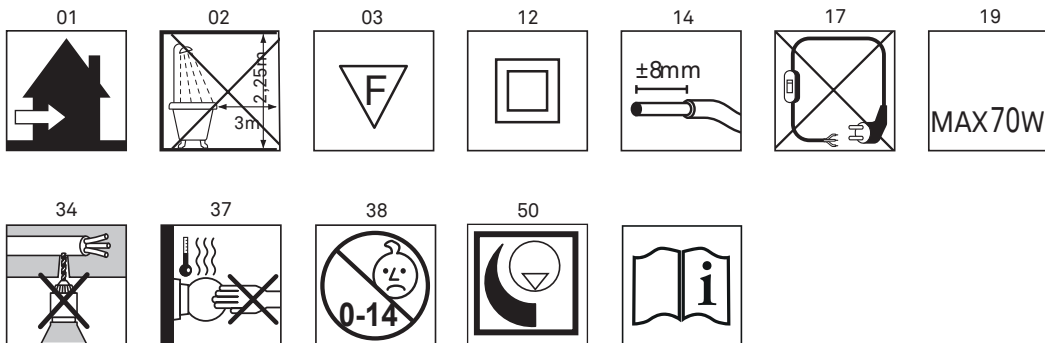

D92=18

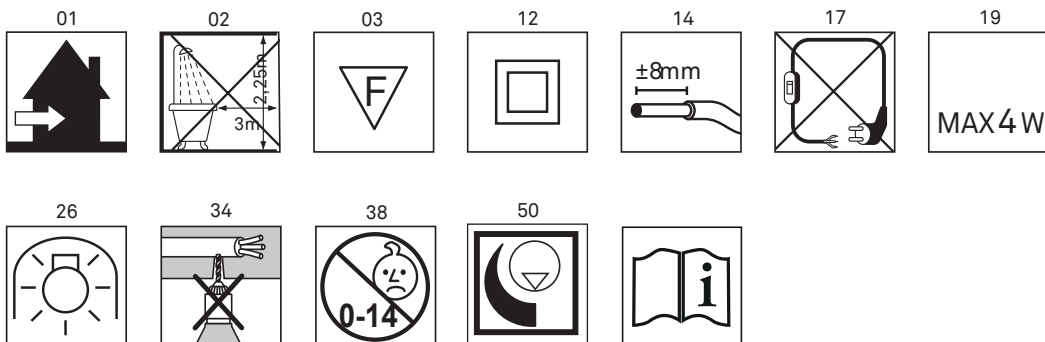

D92=30

01



02

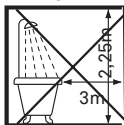

03



12

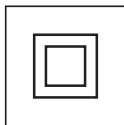

14

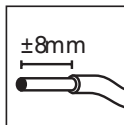

17

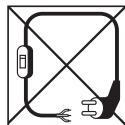

19



34

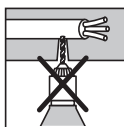

37

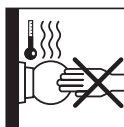

38



50



D92V14

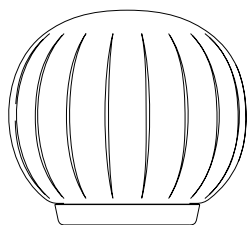

12 cm
4.7"

14 cm

5.5"

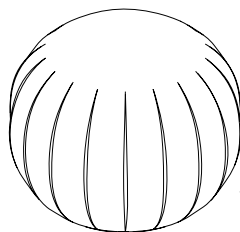

x1

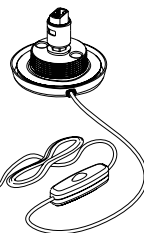

x1



kg 0,6 kg **lb** 1.3 lb

D92V18+D92/2

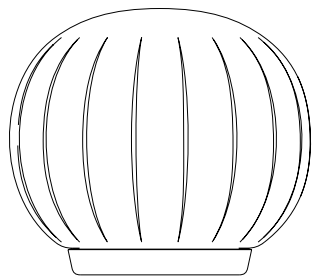

15 cm
5.9"

18 cm

7"

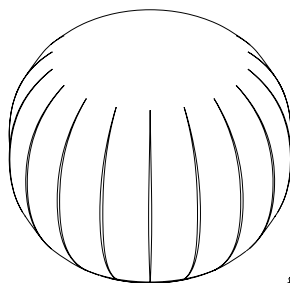

x1

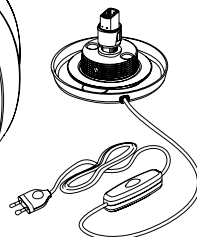

x1



kg 0,8 kg **lb** 1.7 lb

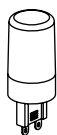

MAX
4W
LED
G9
h max: 70 mm

D92V30+D92/3

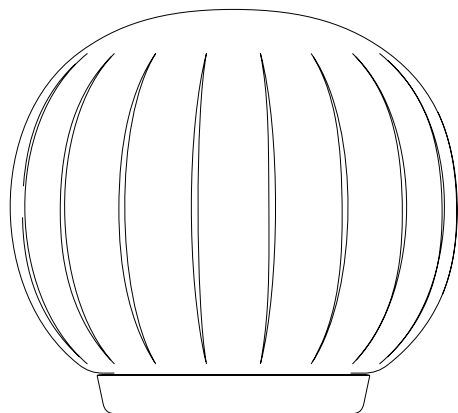

26 cm
10"

30 cm

11.8"

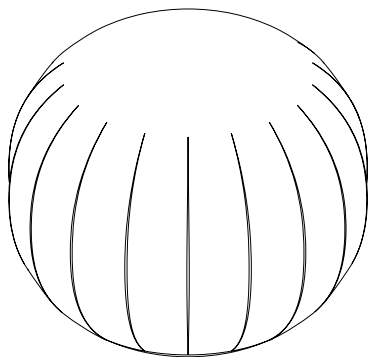

x1

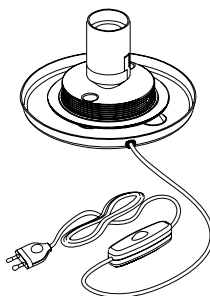

x1

kg 2,2 kg

lb 4.8 lb



MAX
16W
LED
E27



MAX
70W
E27

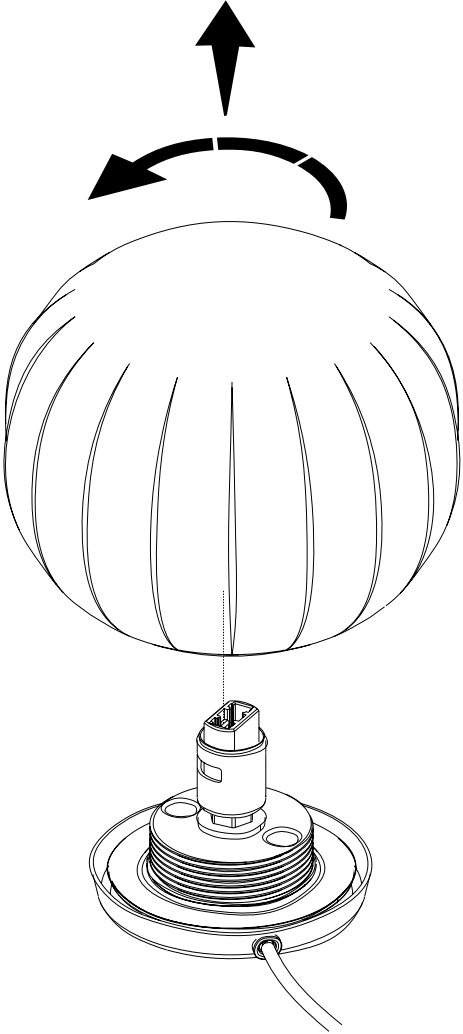

1

D92V14 - D92V18

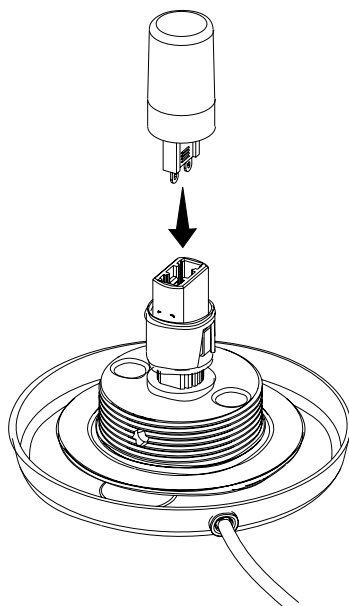

D92V30

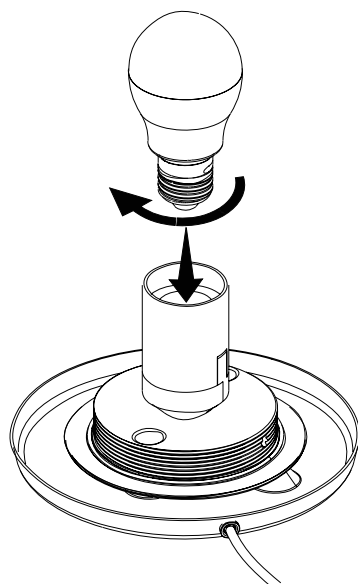

2

D92V14

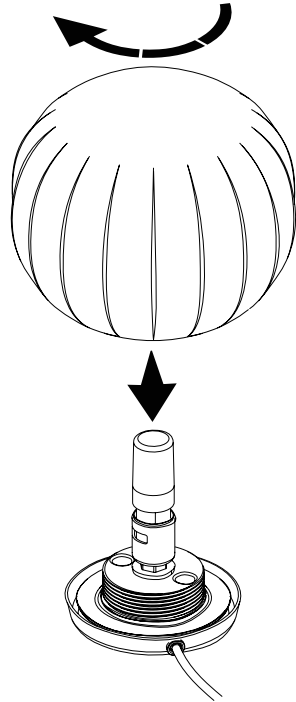

D92V18 - D92V30

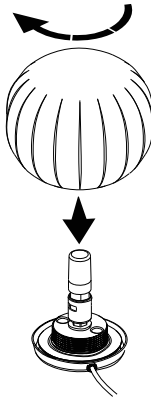
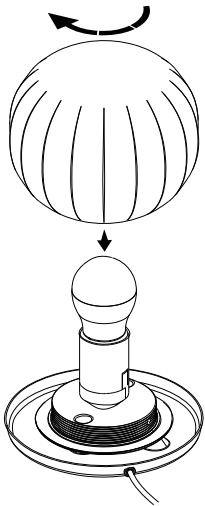

D92=18+D92/2



a



b

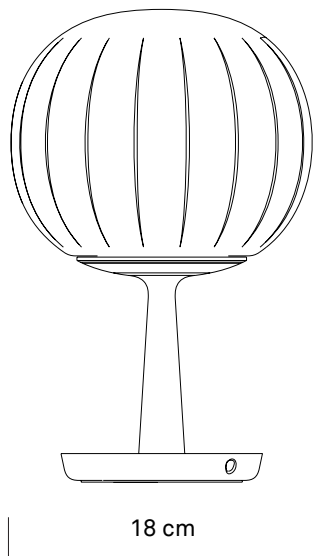

18 cm

7"

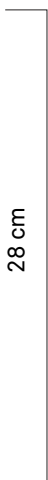

11.2"

28 cm

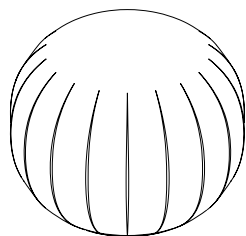

x1

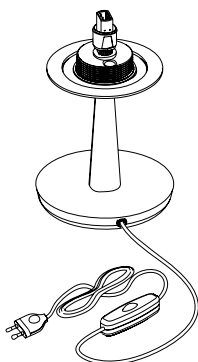

x1

kg 1,5 kg

lb 3.3 lb



MAX
4W
LED
G9
h max: 70 mm

D92=18+D92/3

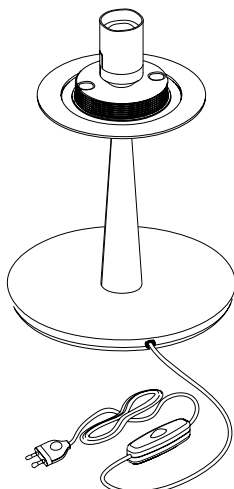
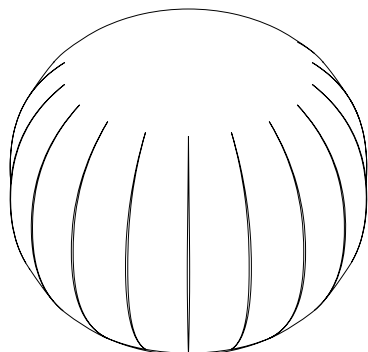
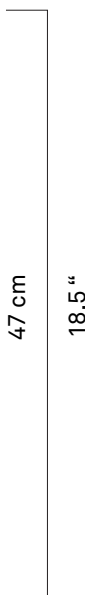
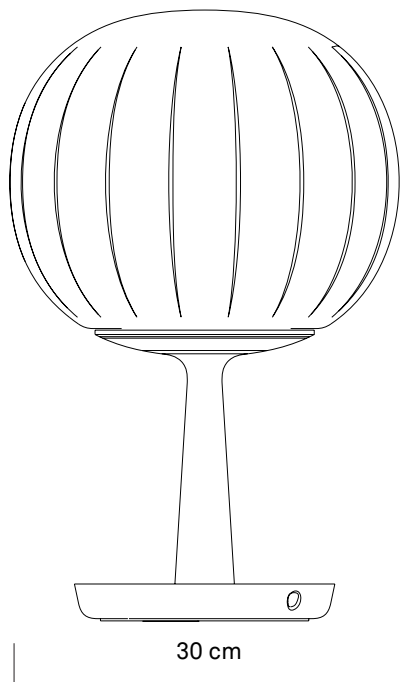

x1

x1

kg 3,0 kg

lb 6.6 lb



MAX
16W
LED
E27



MAX
70W
E27

1

D92=18

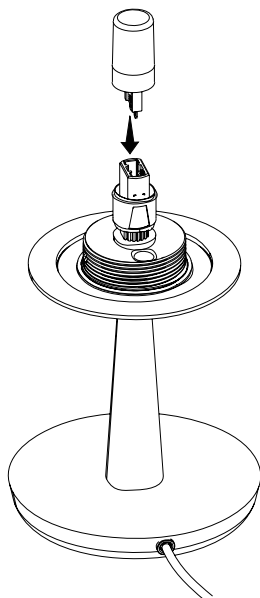

D92=30

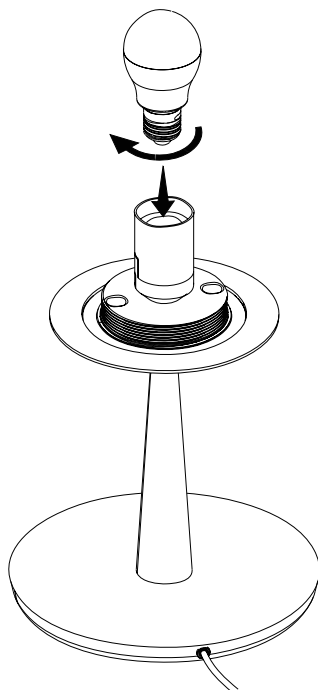

2

D92=18

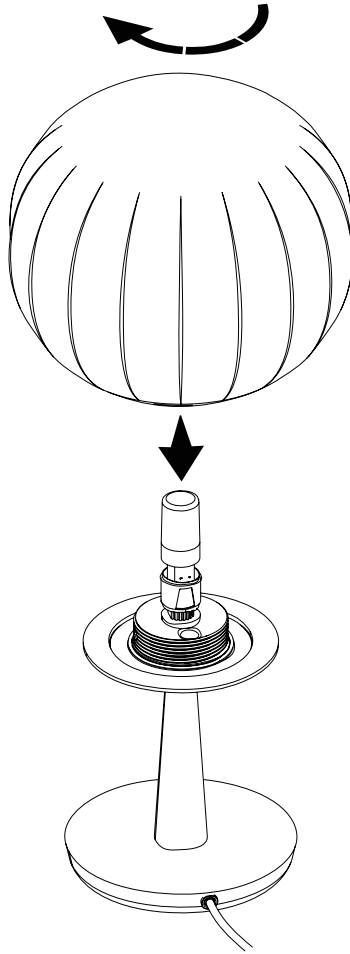

D92= 30

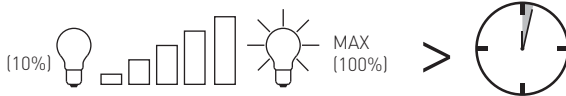
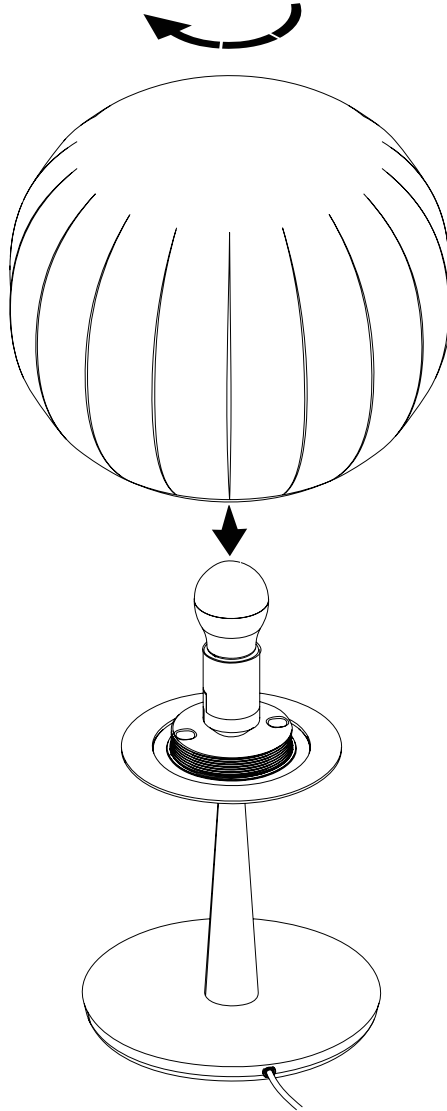

3

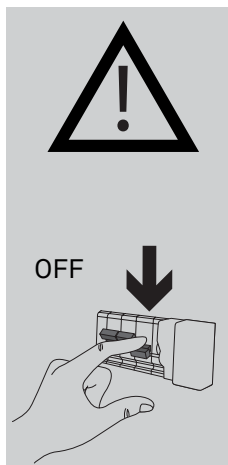

1.

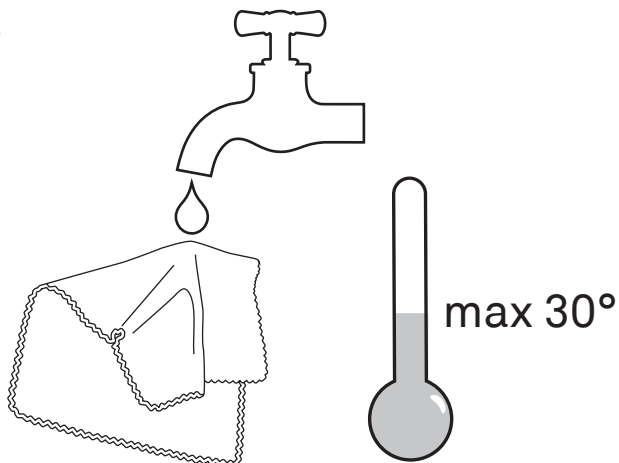

2.

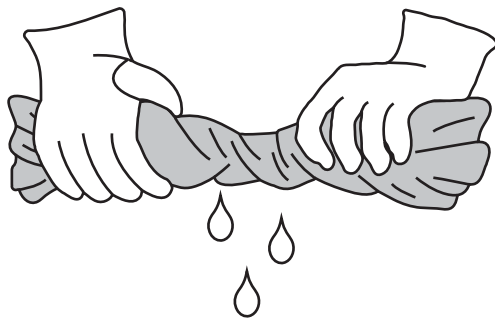

3.





www.luceplan.com

D920IA002