

Occhio

# Mito sospeso move up

Montageanleitung

Mounting instructions

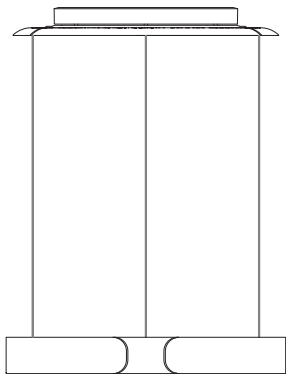



# Inhalt / Contents

Sicherheitshinweise	04	Safety precautions	05
Produktbeschreibung	06	Product description	07
<b>Schritt 1</b>		<b>Step 1</b>	
<b>Montage</b>	<b>09</b>	<b>Mounting</b>	<b>09</b>
Seiteneinspeisung (optional) /	17	Sideways inlet (optional)	17
<b>Schritt 2</b>		<b>Step 2</b>	
<b>Steuerung</b>	<b>25</b>	<b>Control</b>	<b>25</b>
Anhang	31	Appendix	31
Pflegehinweise	32	Care instructions	32
Info & Kontakt	33	Information & contact	33
Technische Daten	34	Technical data	35

# Sicherheitshinweise

Lesen Sie die Montage-/Gebrauchsanweisung sorgfältig durch, bevor Sie die Leuchte installieren. Beachten Sie die Sicherheitshinweise in dieser Anleitung genau und bewahren Sie die Anleitung auf.



Dieses Zeichen macht Sie auf eine gefährliche Situation aufmerksam, die eine schwere Verletzung oder den Tod nach sich ziehen kann, wenn sie nicht beachtet wird. Es macht Sie zudem auf mögliche Sachschäden und andere wichtige Informationen in Verbindung mit diesem Produkt aufmerksam.



Die Montage von Elektrokomponenten darf nur von qualifiziertem Fachpersonal durchgeführt werden. Reparaturarbeiten dürfen nur von autorisiertem Fachpersonal oder dem Hersteller durchgeführt werden. Vor allen Arbeiten an der Leuchte (Installation, Reinigung etc.) diese unbedingt vom Stromnetz trennen.



Dieses Zeichen macht Sie auf Situationen aufmerksam, bei denen Sie direkt in das Licht der LED blicken könnten. Dies kann zu Nachbildern und bei längerer Dauer zu Schädigungen der Augen führen.



Sicherheitsabstand zu brennbaren Objekten einhalten: 20 cm!



Dieses Zeichen macht Sie auf heiße Oberflächen aufmerksam, deren Berührung Verbrennungen zur Folge haben können.

Achtung: Die Oberfläche der Leuchte kann nach längerer Betriebsdauer heiß sein! Vor allen Arbeiten an der Leuchte (Montage usw.), Leuchte immer ausschalten und mindestens 30 Minuten abkühlen lassen.

## Safety precautions

Read through the mounting/ use instructions carefully before installing the luminaire. Follow the safety precautions in these instructions closely and keep the instructions in a safe place.



This symbol warns you of a dangerous situation which could lead to serious injury or even death if the instructions are not observed. It also draws your attention to possible material damage and provides other important information in connection with this product.



The assembly and installation of electrical components must be carried out only by qualified personnel. Repairs must be carried out only by authorised, qualified personnel or the manufacturer. Before performing any work on the luminaire (installation, cleaning, etc.), it must be disconnected from the mains supply.



This symbol draws your attention to situations in which you could look directly into the light of the LED. This may cause an after-image effect and may result in damage to the eyes if you look at the light directly for prolonged periods.



Maintain the minimum safety distance from flammable materials: 20 cm.



This symbol warns you of hot surfaces, which could cause burns if touched.

Caution: When used for prolonged periods, the surface of the luminaire can become hot. Before performing any work on the luminaire (fitting the luminaire etc.), always switch the luminaire off and let it cool for at least 30 minutes.

# Produktbeschreibung

Ringförmige LED Pendel- und Deckenleuchte mit beidseitigem Lichtaustritt und einem Durchmesser von 40 cm oder 60 cm. Es stehen zwei Lichtwirkungen zur Wahl. table (wide) für die Anwendung über Tischen – breit abstrahlendes Licht nach unten und oben. room (narrow) für frei im Raum hängende Leuchten – gebündeltes Licht nach unten, diffuses Licht nach oben.

Die Pendellänge ist stufenlos, elektrisch einstellbar von 50–200 cm.

Version mit integriertem Vorschaltgerät für Aufputzmontage, Anschluss an 230 V AC Netzspannung. Steuerbar über »touchless control« (Gestensteuerung am head) oder Occhio air. Die Farbtemperatur ist stufenlos steuerbar via »touchless control« oder Occhio air von 2700–4000 K

## Product description

Annular LED suspended and ceiling luminaire with double-sided light emission and a diameter of 40 cm or 60 cm. There is a choice of two lighting effects. table (wide) for use over tables – wide light beam downwards and upwards. room (narrow) for freely suspended luminaire lighting – concentrated light beam directed downwards, diffused light directed upwards.

The suspension length is continuously, electrically adjustable from 50 to 200 cm.

Version with integrated power supply unit for mounting on plaster surfaces; connection to 230 V AC mains voltage. Can be controlled via »touchless control« (gesture control on the head) or Occhio air. The color temperature can be continuously controlled via »touchless control« or Occhio air from 2700 to 4000 K.





Montage

Mounting

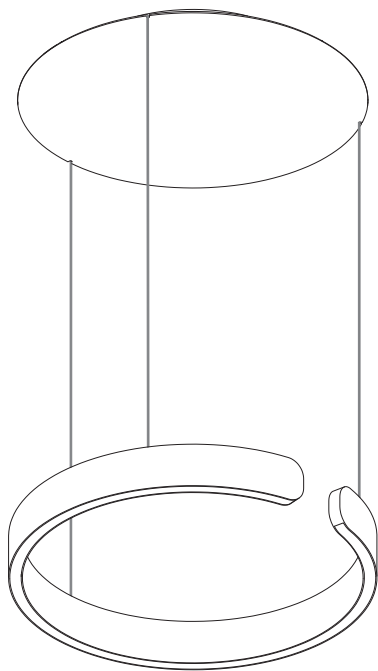

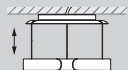

Deckenauslass / ceiling outlet  
230V AC

Dübel / screw anchor

Deckenbefestigung inkl. Konverter /  
ceiling mount incl. converter

Montageseil / mounting cord

Schrauben / screws

Baldachin mit elektrischer  
Höhenverstellung / canopy with  
electric height adjustment

Mito sospeso head

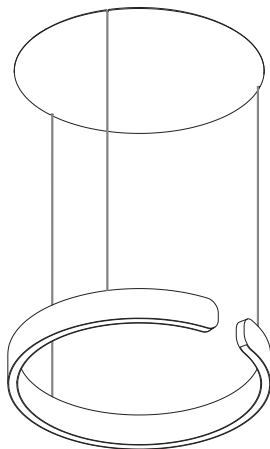
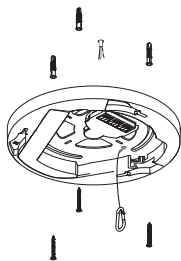

## Montage / Mounting

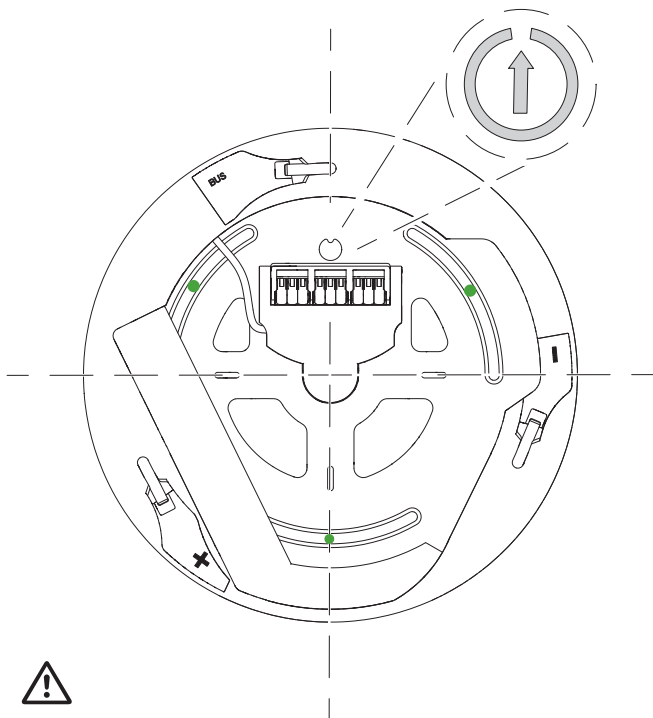

**Ausrichtung beachten!**

**Observe alignment!**

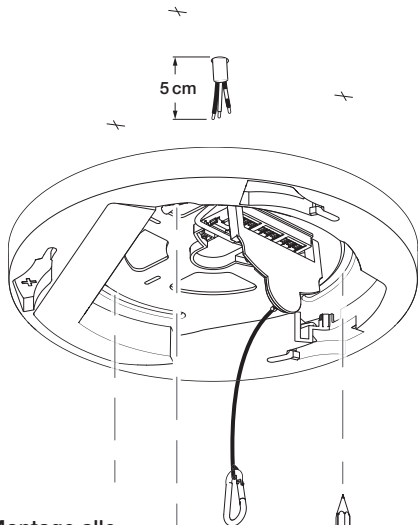
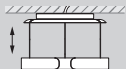

**Achtung!**  
Vor der Montage alle  
stromführenden Leitungen  
vom Stromnetz trennen!



**Caution!**  
Before mounting, disconnect  
all currentcarrying lines  
from the mains supply!

# Montage / Mounting

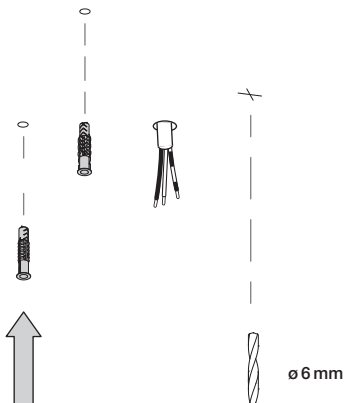

**Achtung!**  
Auf den Verlauf von  
Stromleitungen achten!



**Caution!**  
Check the routing of the  
power cables.

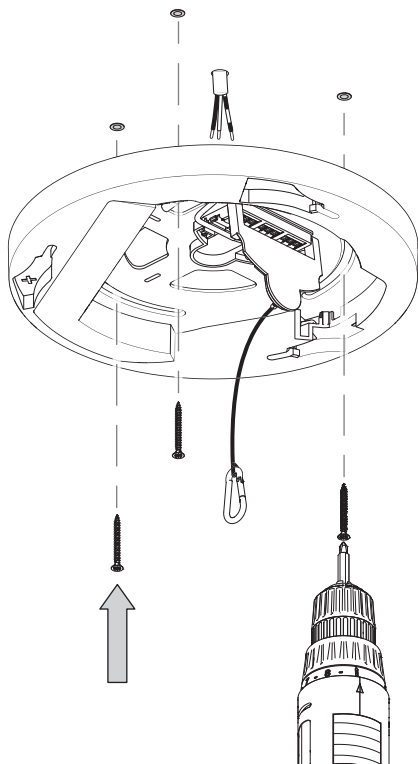
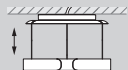

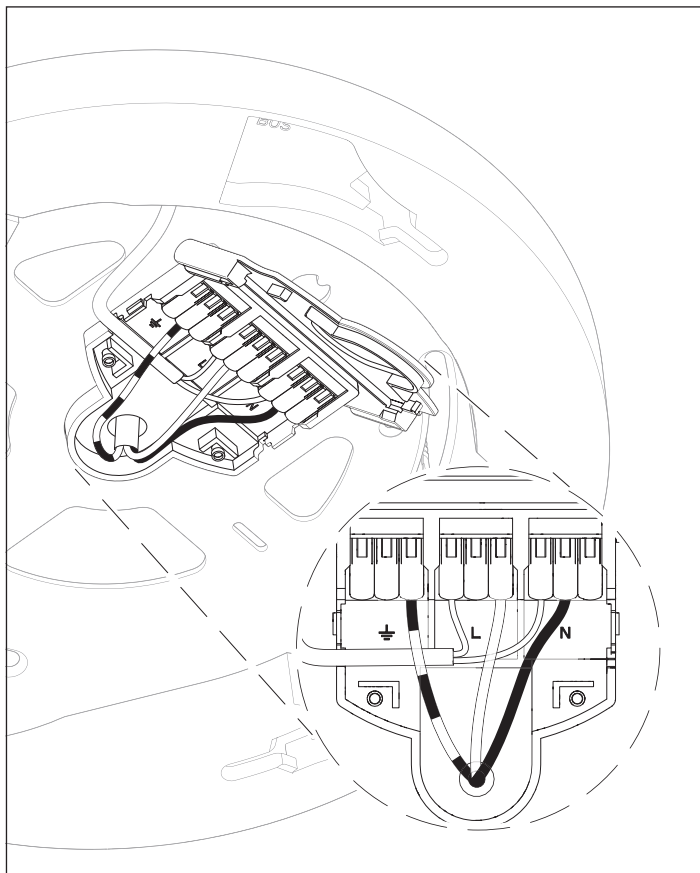



# Seiteneinspeisung (optional) / Sideways inlet (optional)

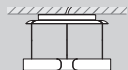

Falls der Kabeleinlass der Leuchte nicht verwendet werden kann, besteht die Möglichkeit der Seiteneinspeisung an einer Stelle.

If the cable inlet of the luminaire cannot be used, it is possible to feed the power from the side at one point.

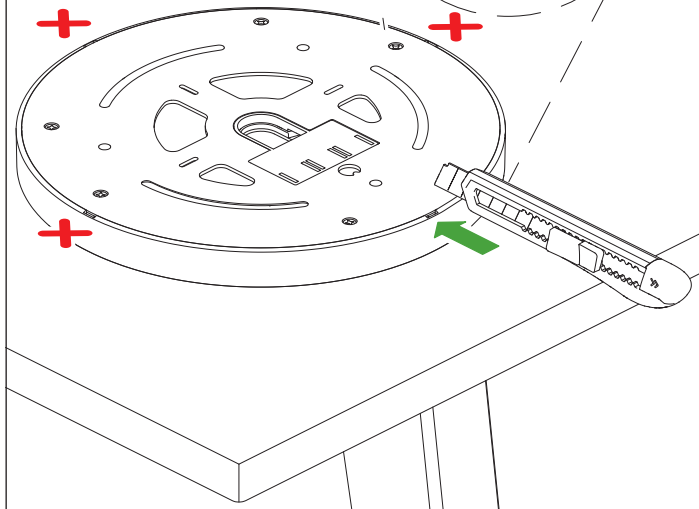
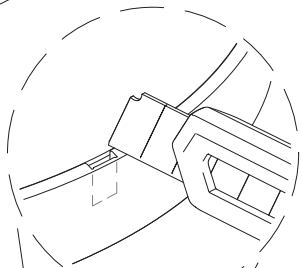

## Seiteneinspeisung (optional) / Sideways inlet (optional)

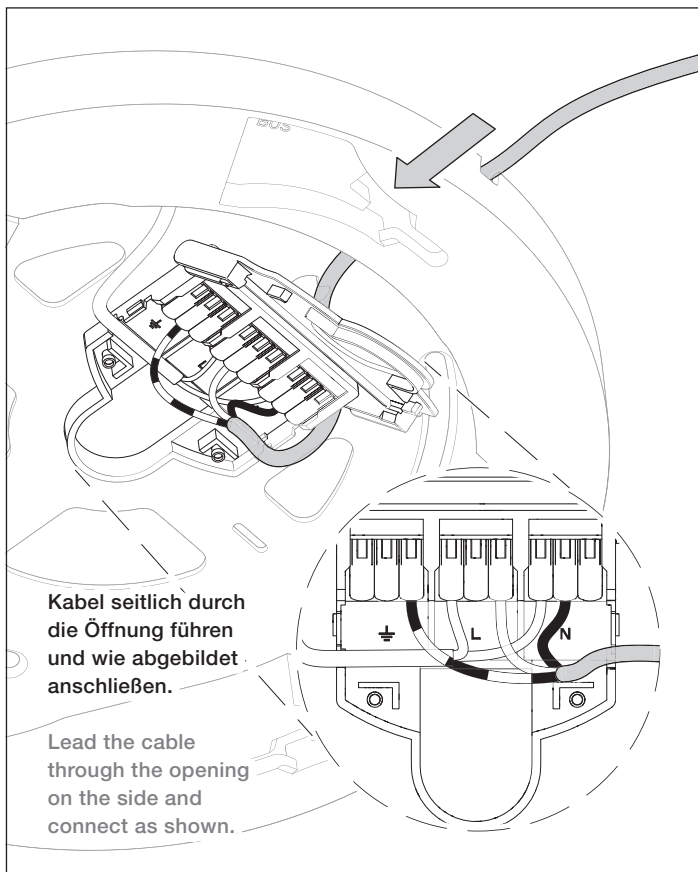

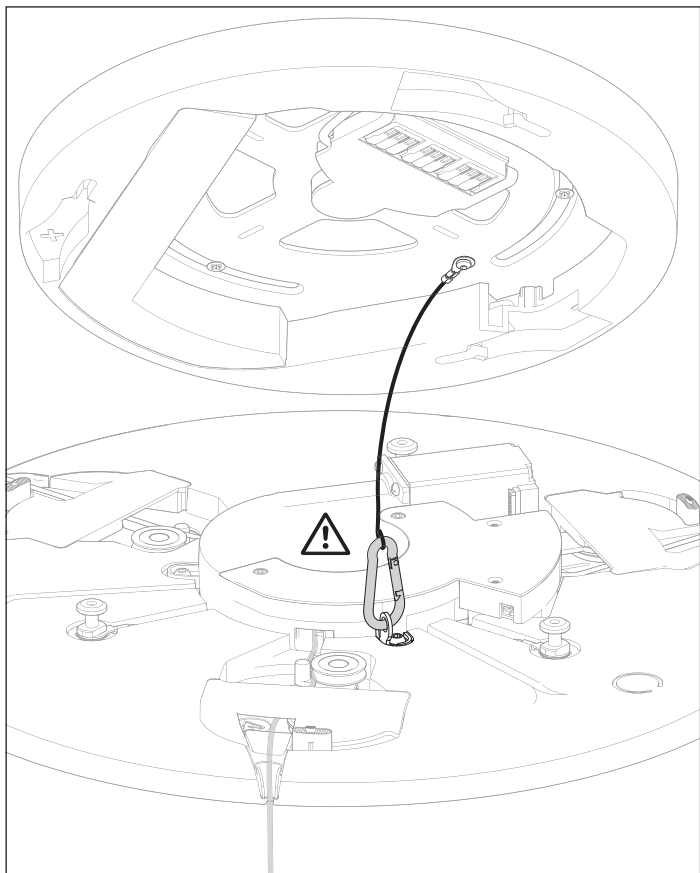
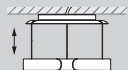

## Montage / Mounting

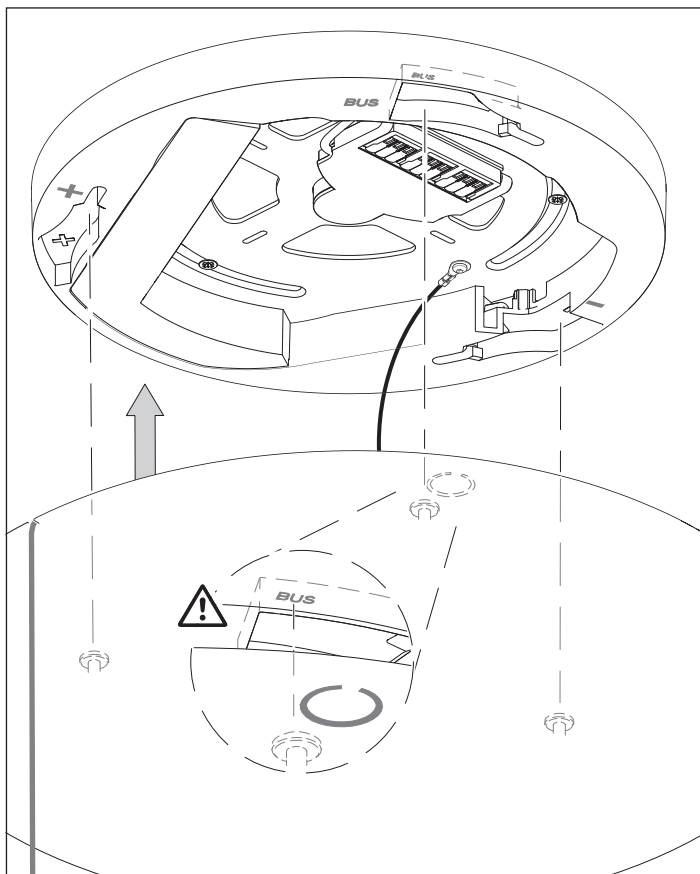

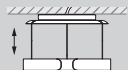

**Baldachin drehen, bis  
dieser hörbar einrastet  
und Markierung prüfen!**

Turn canopy until you  
hear it click into place  
and check sign!

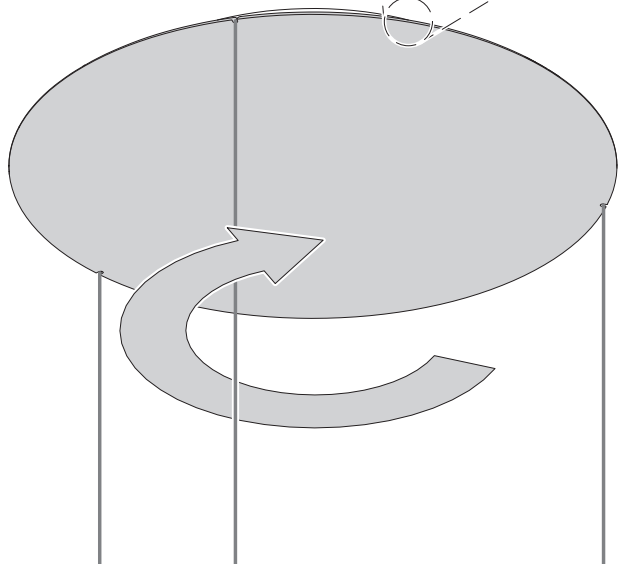
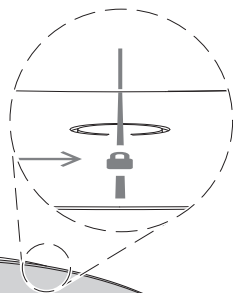

## Montage / Mounting

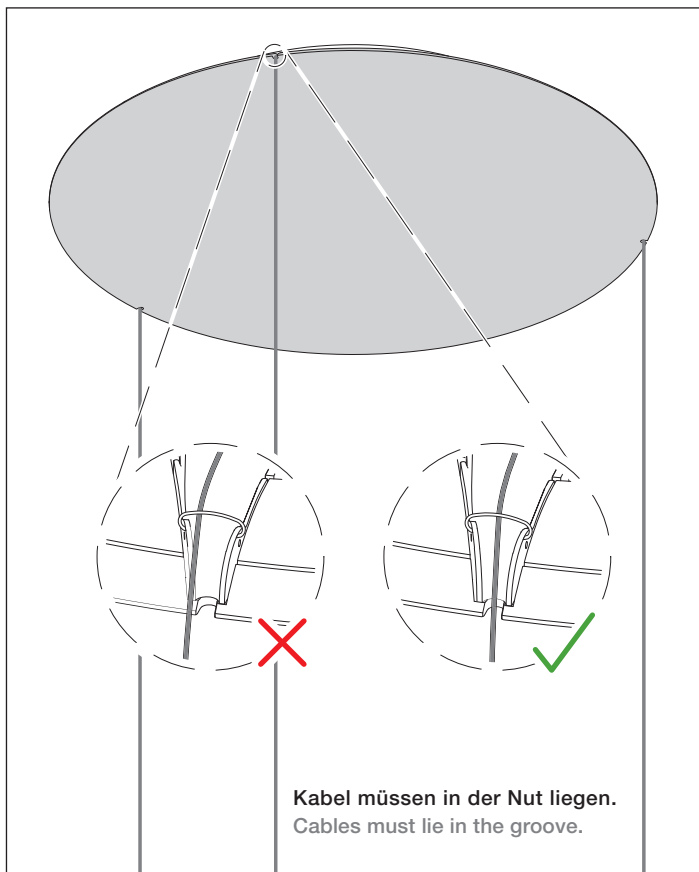

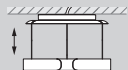

**Feinjustierung.  
Die Leuchte  
ist nun fertig  
montiert.**

Fine adjustment.  
The luminaire is  
now fully assem-  
bled.

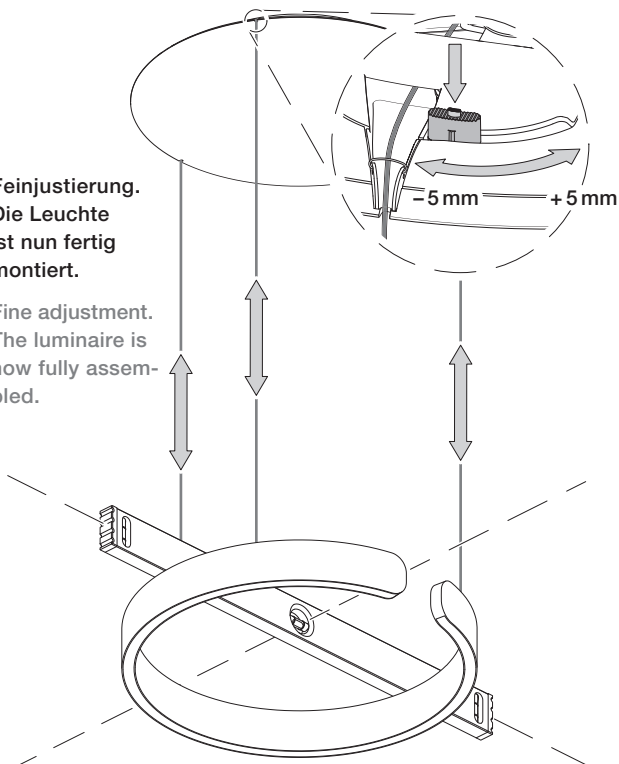





Steuerung

Control

» touchless control « + » air «

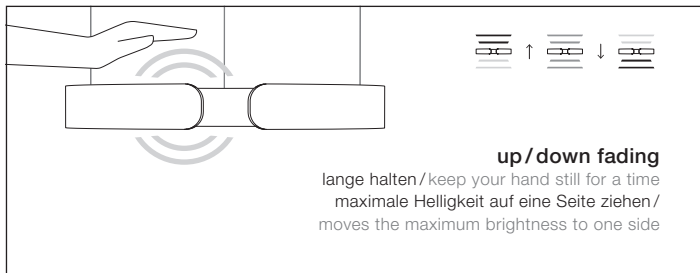
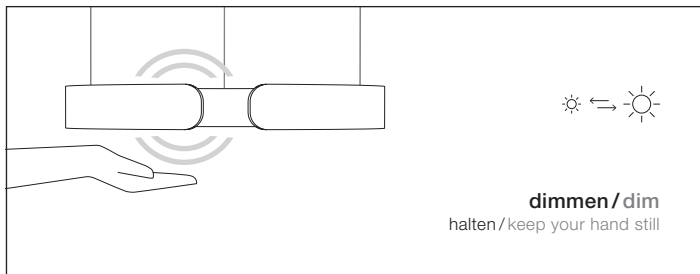
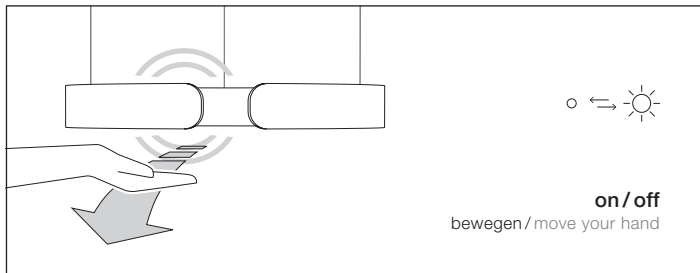

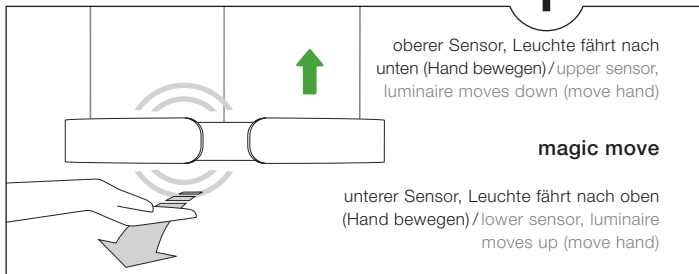
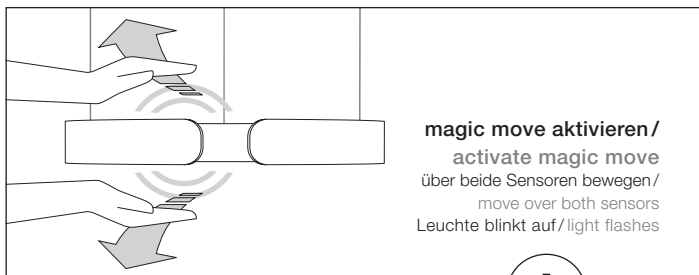
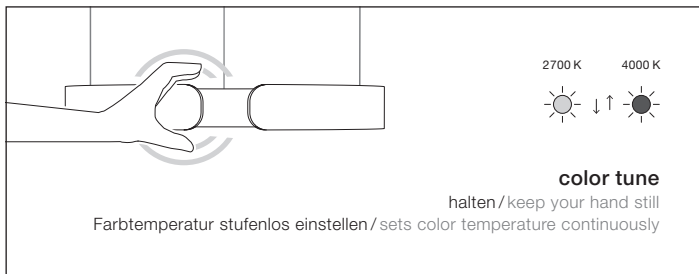

Leuchte stoppt bei Erkennen von Hindernissen selbstständig (auch wenn der Sensor deaktiviert ist) /  
Luminaire stops automatically when obstacles are detected (even if sensor is deactivated)

## »touchless control« + »air«



Die Funktion »touchless control« kann via Occhio air deaktiviert werden. Siehe separates Handbuch.

The function »touchless control« can be deactivated via Occhio air. See separate manual.

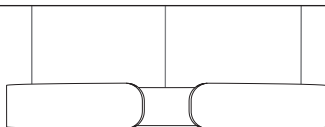

Steuerung und erweiterte Einstellungen via Occhio air.  
Siehe separates Handbuch.

Control and advanced settings via Occhio air.  
See separate manual.







Anhang

Appendix

## Pflegehinweise

### Care instructions

Leuchte nur in abgekühltem Zustand reinigen! Zur Reinigung der Leuchte ein trockenes Mikrofasertuch verwenden. Detaillierte Pflegehinweise sind unter [www.occhio.com/faq](http://www.occhio.com/faq) zu finden.

Always allow the luminaire to cool down before cleaning! To clean the luminaire, use a dry microfibre cloth. Detailed care instructions are available at [www.occhio.com/faq](http://www.occhio.com/faq).



## Info & Kontakt

### Information & contact



Weitere Fragen beantwortet gerne  
Ihr Occhio Fachhändler

Your Occhio specialist retailer will  
gladly answer any other questions

**[www.occhio.com](http://www.occhio.com)**  
**[info@occhio.com](mailto:info@occhio.com)**

# Technische Daten

## Technische Daten Leuchte

Artikelbezeichnung	Mito sospeso 40 move up, Mito sospeso 60 move up
Abmessungen	Mito sospeso 40: head ø 400, H 52 mm, Baldachin ø 380 mm, H 41 mm Mito sospeso 60: head ø 600, H 52 mm, Baldachin ø 580 mm, H 41 mm
Höhenverstellung	500 – 2000 mm (variabel, nicht für Dauerbetrieb ausgelegt)
Schutzklasse	2
Anschluss	230 V AC
Dimmung	via »touchless control«, Occhio air
Material	Aluminium, Stahl, lackiert, PVD-beschichtet, Kunststoff, optischer Silikon, Fiberglas
LED-Leistung	Mito sospeso 40 move up: 40 W Mito sospeso 60 move up: 60 W
Zulässige Betriebsbedingung	max. 30°C nur im Innenbereich betreiben
Prüfzeichen	IP 20 CE   

## Technische Daten Leuchtmittel



Leuchtmittel	Occhio »color tune« LED
Ausführung	LED-board
Lebensdauer	> 50.000 Std.

## Entsorgung

Bei örtlicher Entsorgungsstelle entsorgen. Mito sospeso move up ist recyclebar; RoHS-konform. **Nicht in den Hausmüll geben!**

# Technical data

## Technical data luminaire

Product designation	Mito sospeso 40 move up, Mito sospeso 60 move up
Dimensions	Mito sospeso 40: head ø 400, H 52 mm, canopy ø 380 mm, H 41 mm Mito sospeso 60: head ø 600, H 52 mm, canopy ø 576 mm, H 41 mm
Height adjustment	500 – 2000 mm (variable, not designed for continuous operation)
Safety class	2
Connection	230 V AC
Dimming	via »touchless control«, Occhio air
Material	Aluminium, painted, PVD-coated steel, plastic, optical silicone, fibreglass
LED power	Mito sospeso 40 move up: 40 W Mito sospeso 60 move up: 60 W
Permitted operating conditions	max. 30°C for indoor use only
Test symbols	IP 20     

## Technical data light source

Light source	Occhio »color tune« LED
Version	LED-board
Lifetime	> 50.000 h

## Disposal

Dispose of at a local disposal site. Mito sospeso move up is recyclable and RoHS compliant. **Do not dispose of with the household waste!**

# Occhio

[www.occhio.com](http://www.occhio.com)



010405944551195010