



Catellani & Smith®



Disco

round Ø60 cm

ceiling

ISTRUZIONI DI MONTAGGIO / ASSEMBLY INSTRUCTIONS / INSTRUCTIONS DE MONTAGE / MONTAGEANLEITUNGEN / INSTRUCCIONES DE MONTAJE

I AVVERTENZE





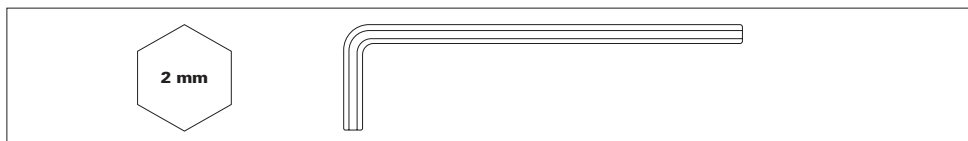

- Si raccomanda che l'installazione venga eseguita da un elettricista abilitato.
- Togliere la tensione di alimentazione prima di effettuare l'installazione e per interventi di manutenzione o in caso di cattivo funzionamento.
- La lampada è fornita di tasselli con bordo di arresto in nylon Ø 6x40 mm per muratura. Si consiglia di verificare la tipologia di tasselli corretta per la vostra parete/soffitto e, se necessario, acquistarli separatamente.
- Si consiglia l'utilizzo dei guanti in dotazione. Per la pulizia della superficie utilizzare un piumino rimuovi-polvere.
- La lampada acquistata è garantita se installata e utilizzata nel rispetto delle specifiche del modello. Catellani & Smith declina ogni responsabilità per installazione non appropriata e/o uso diverso da quello indicato.

GB WARNINGS

- Only a qualified electrician should execute the installation.
- Switch off the power supply before installing, servicing or in case of malfunctioning.
- The lamp is supplied with nylon plugs Ø 6x40 mm for wall mounting. We suggest to check the correct plugs for your type of wall/ceiling and acquire them separately if those included are not suitable.
- We suggest you to use the gloves provided. We recommend using a feather duster to clean the surfaces.
- The purchased lamp is guaranteed if installed and used in accordance with to the specifications of the model. Catellani & Smith is not responsible for inappropriate installation of the product and/or a different use than the one indicated.

UTENSILI INCLUSI / TOOLS SUPPLIED



tensione di rete / voltage		fonte luminosa / light source	alimentatore / driver	dimmerazione / dimming	
110V		1x 12W COB LED @350mA	alimentatore in corrente costante	DALI	
		1x 12W COB LED @350mA	constant current driver	DALI	
230V		1x 15W COB LED @450mA	alimentatore in corrente costante	TRIAC	
		1x 15W COB LED @450mA	constant current driver	TRIAC	
I classe class	IP20 classe di protezione protection class	 persone suggerite per il montaggio people required for mounting	  ↔ 		 MADE IN ITALY

PER RAGIONI DI SICUREZZA, SI CONSIGLIA DI SPELARE IL CAVO PER MAX 7 MM.
FOR SAFETY REASONS WE SUGGEST NOT TO STRIP THE WIRE MORE THAN 7 MM.

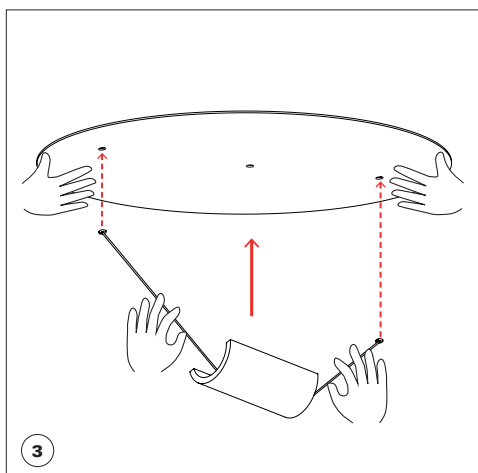
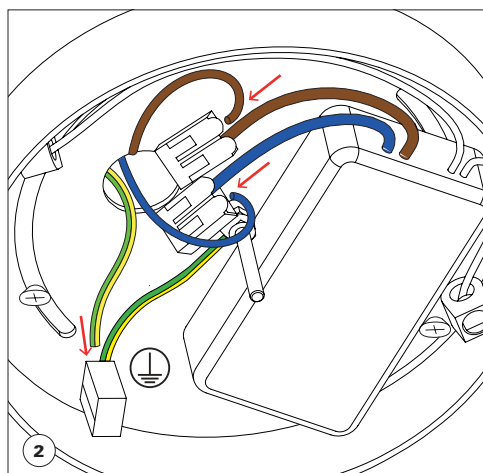
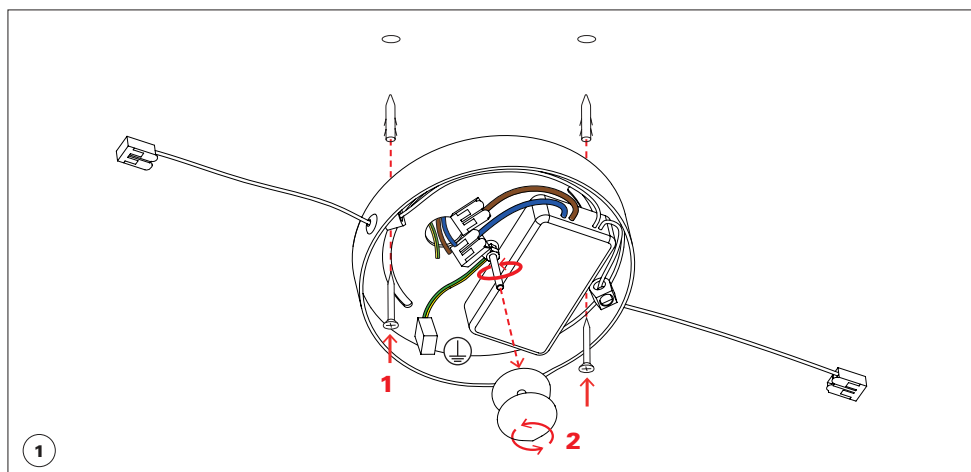

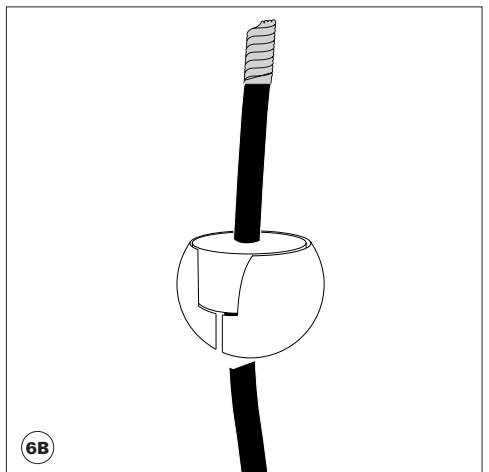
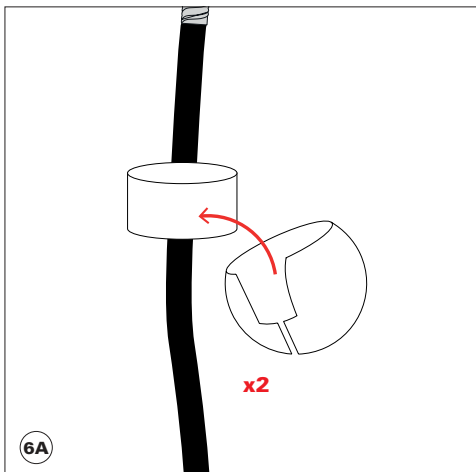
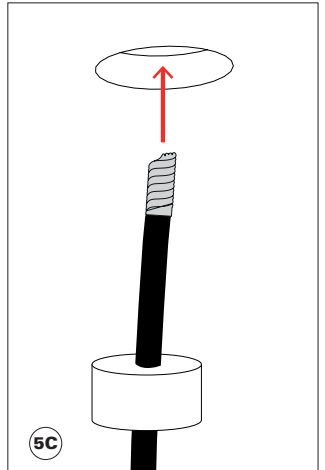
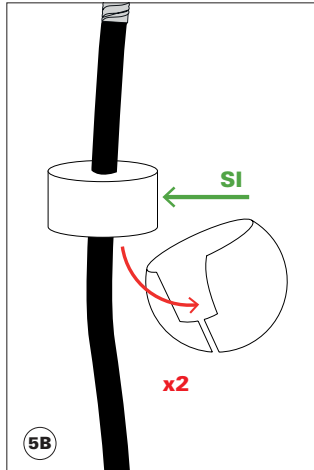
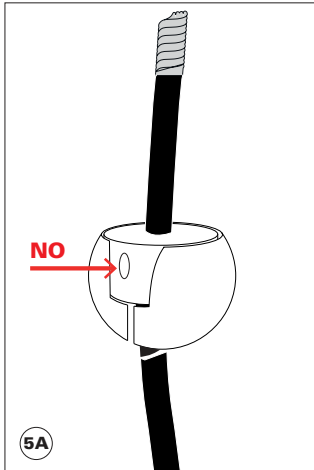
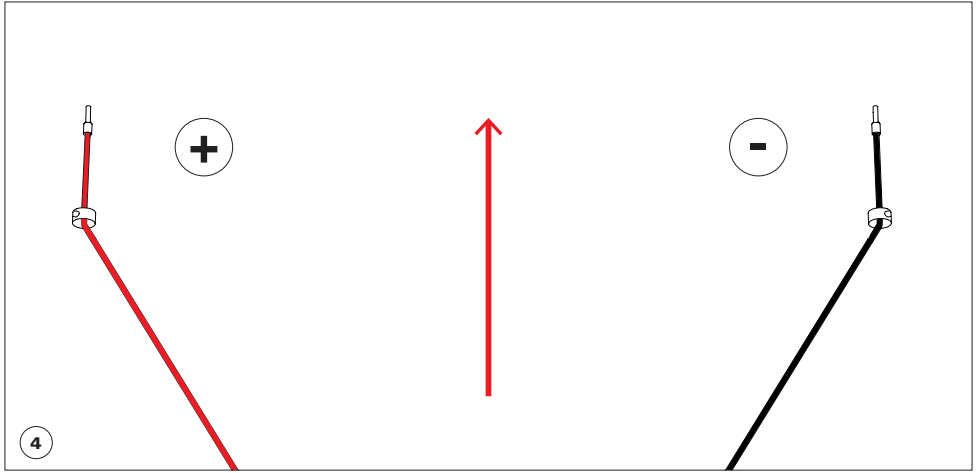

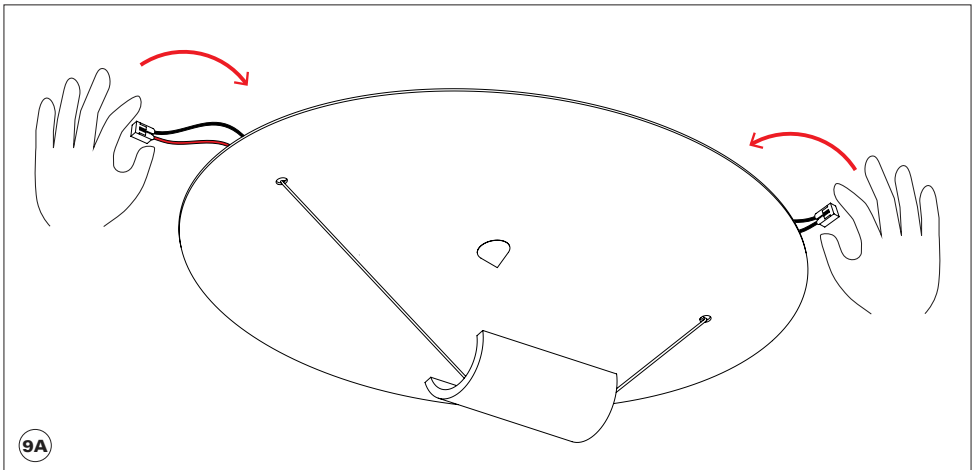
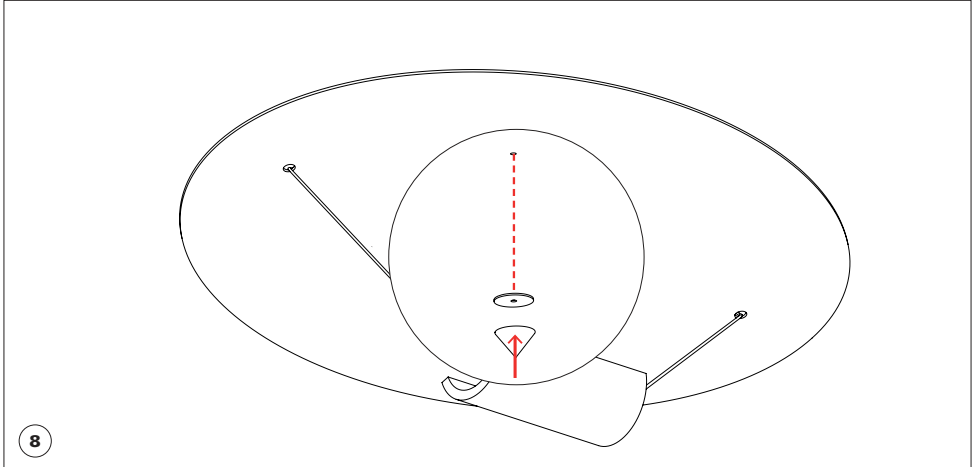
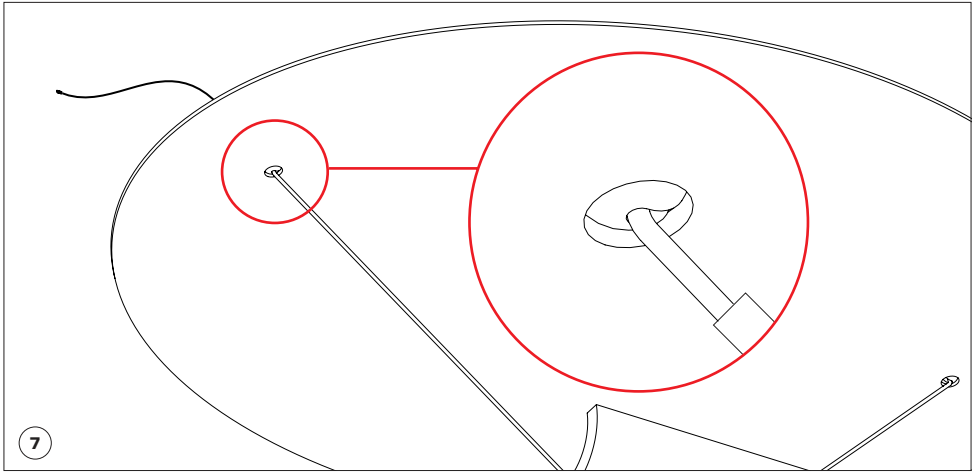

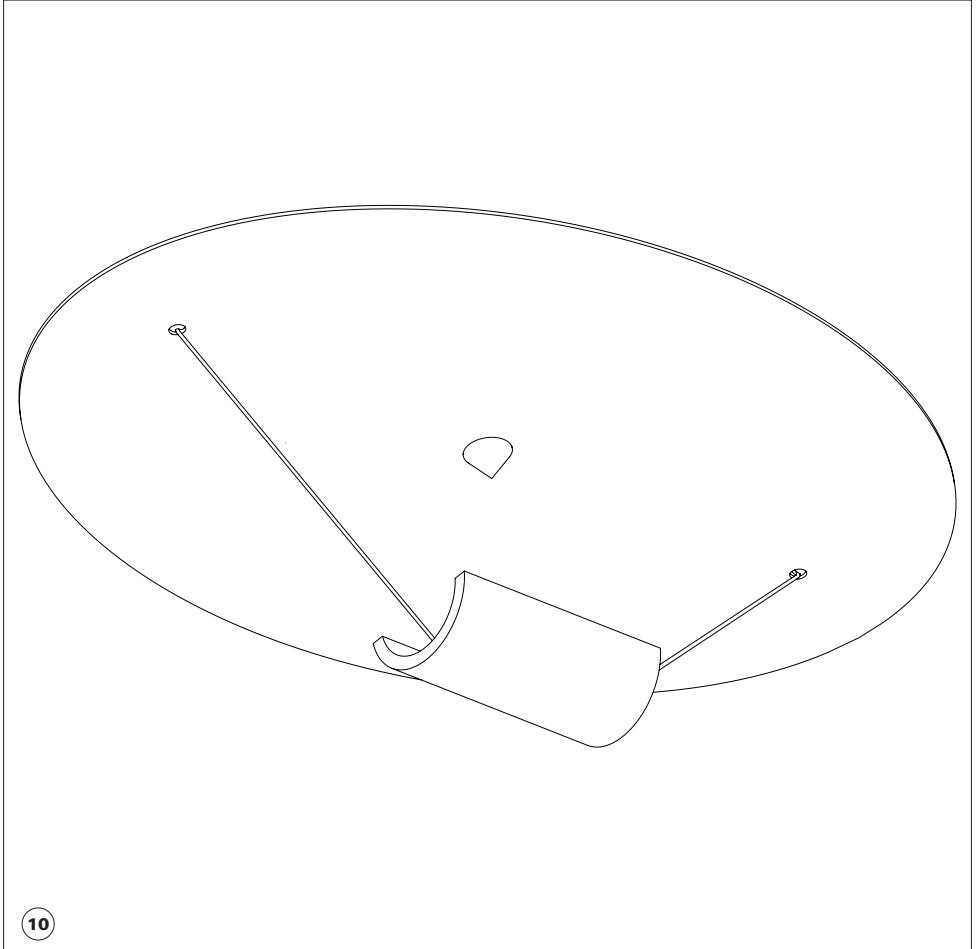
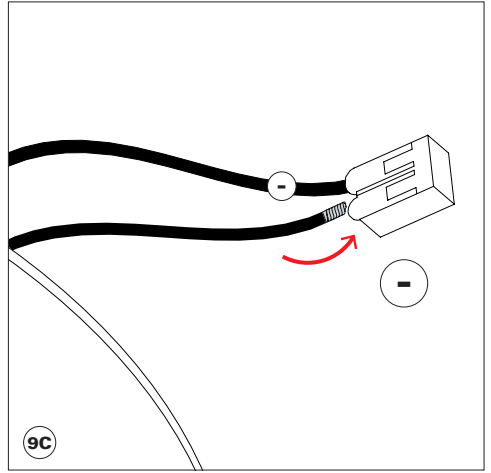
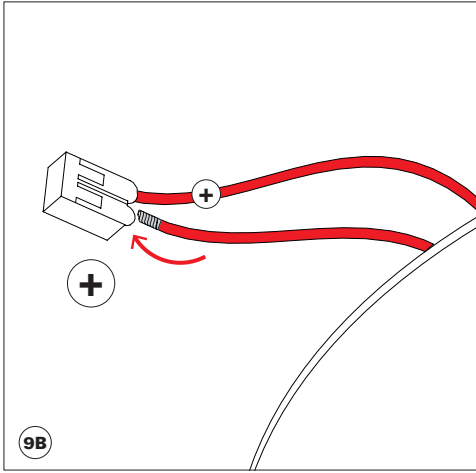



updated 04/2024

Questa apparecchiatura non deve essere smaltita come un normale rifiuto urbano, ma deve essere portata nel punto di raccolta appropriato per il riciclaggio di apparecchiature elettriche ed elettroniche. Provvedendo a smaltire questo prodotto in modo appropriato, si contribuisce ad evitare potenziali conseguenze negative per l'ambiente e per la salute umana, che potrebbero derivare da uno smaltimento inadeguato del prodotto. Per informazioni più dettagliate sul riciclaggio di questo prodotto, contattare l'ufficio comunale, il servizio locale di smaltimento rifiuti o il rivenditore presso il quale è stato acquistato il prodotto.

This equipment may not be treated as household waste. Instead it shall be handed over to the applicable collection point for the recycling of electrical and electronic equipment. By ensuring this product is disposed of correctly, you will help prevent potential negative consequences for the environment and human health, which could otherwise be caused by inappropriate waste handling of this product. For more detailed information about the recycling of this product, please contact your local city office, your household waste disposal or the dealer where you purchased this product.

