

Occhio

Mito sfera su

Montageanleitung
Mounting instructions

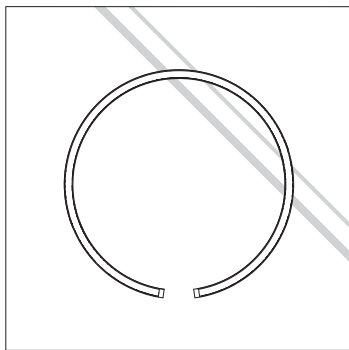

Inhalt / Contents

Sicherheitshinweise	04	Safety precautions	05
Produktbeschreibung	06	Product description	07
Schritt 1		Step 1	
Steuerung	09	Control	09
Mito set box (standard)	11	Mito set box (standard)	11
Mito »air« box (optional)	21	Mito »air« box (optional)	21
Schritt 2		Step 2	
Vorbereitungen	29	preparation	29
Schritt 3		Step 3	
Montage	33	Mounting	33
Vorschaltgerät hinter dem Spiegel		power supply unit behind the mirror	
Seiteneinspeisung (optional)	46	sideways inlet (optional)	46
Montage	49	Mounting	49
Vorschaltgerät in Revision	49	power supply unit in revision	49
Steuerung mit der Occhio air App (optional)	65	Control using the Occhio air app (optional)	65
Steuerung mit dem Occhio air controller (optional)	73	Control using the Occhio air controller (optional)	73
Anhang	77	Appendix	77
Pflegehinweise	78	Care instructions	78
Info & Kontakt	79	Information & contact	79
Technische Daten	80	Technical data	81

Sicherheitshinweise

Lesen Sie die Montage-/Gebrauchsanweisung sorgfältig durch, bevor Sie die Leuchte installieren. Beachten Sie die Sicherheitshinweise in dieser Anleitung genau und bewahren Sie die Anleitung auf.



Dieses Zeichen macht Sie auf eine gefährliche Situation aufmerksam, die eine schwere Verletzung oder den Tod nach sich ziehen kann, wenn sie nicht beachtet wird. Es macht Sie zudem auf mögliche Sachschäden und andere wichtige Informationen in Verbindung mit diesem Produkt aufmerksam.



Die Montage von Elektrokomponenten darf nur von qualifiziertem Fachpersonal durchgeführt werden. Reparaturarbeiten dürfen nur von autorisiertem Fachpersonal oder dem Hersteller durchgeführt werden. Vor allen Arbeiten an der Leuchte (Installation, Reinigung etc.) diese unbedingt vom Stromnetz trennen.



Dieses Zeichen macht Sie auf Situationen aufmerksam, bei denen Sie direkt in das Licht der LED blicken könnten. Dies kann zu Nachbildern und bei längerer Dauer zu Schädigungen der Augen führen.



Sicherheitsabstand zu brennbaren Objekten einhalten: 20 cm!



Dieses Zeichen macht Sie auf heiße Oberflächen aufmerksam, deren Berührung Verbrennungen zur Folge haben können.

Achtung: Die Oberfläche der Leuchte kann nach längerer Betriebsdauer heiß sein! Vor allen Arbeiten an der Leuchte (Montage usw.), Leuchte immer ausschalten und mindestens 30 Minuten abkühlen lassen. Nur zur Installation außerhalb des Handbereichs vorgesehen.

Safety precautions

Read through the mounting/ use instructions carefully before installing the luminaire. Follow the safety precautions in these instructions closely and keep the instructions in a safe place.



This symbol warns you of a dangerous situation which could lead to serious injury or even death if the instructions are not observed. It also draws your attention to possible material damage and provides other important information in connection with this product.



The assembly and installation of electrical components must be carried out only by qualified personnel. Repairs must be carried out only by authorised, qualified personnel or the manufacturer. Before performing any work on the luminaire (installation, cleaning, etc.), it must be disconnected from the mains supply.



This symbol draws your attention to situations in which you could look directly into the light of the LED. This may cause an after-image effect and may result in damage to the eyes if you look at the light directly for prolonged periods.



Maintain the minimum safety distance from flammable materials: 20 cm.



This symbol warns you of hot surfaces, which could cause burns if touched.

Caution: When used for prolonged periods, the surface of the luminaire can become hot. Before performing any work on the luminaire (fitting the luminaire etc.), always switch the luminaire off and let it cool for at least 30 minutes. Only for installing in a position which is out of arm's reach.

Produktbeschreibung

Ringförmige LED Wandleuchte zur Montage auf einem Spiegel mit einseitigem Lichtaustritt und einem Durchmesser von 40 cm oder 60 cm. Die Lichtwirkung bietet blendfreies Licht für eine perfekte Ausleuchtung. Version mit externem Vorschaltgerät hinter dem Spiegel oder in Revision, Anschluss an 230V AC Netzspannung.

Steuerbar über »touchless control« (Gestensteuerung am head) oder Occhio air, alternativ dimmbar via Phasenabschnitt-dimmer*. Die Farbtemperatur ist stufenlos steuerbar via »touchless control« oder Occhio air von 2700–4000K oder voreinstellbar (2700 / 3000 / 3500 / 4000 K).

* Liste kompatibler Dimmer: www.occhio.com/dim, Phasenabschnittdimmer und Occhio air sind nicht kombinierbar

Product description

Ring-shaped LED wall luminaire with single-sided light output for mounting on a mirror, available in the following diameters: 40 cm or 60 cm. The lighting effect provides glare-free light for perfect illumination. This version features an external power supply unit behind the mirror or in recess and connects to 230 VAC mains voltage.

The luminaire can be controlled using »touchless control« (gesture control at the head) or Occhio air, or can be dimmed using a trailing-edge phase cut dimmer*. The color temperature is continuously adjustable between 2700–4000 K or can be preset (2700 / 3000 / 3500 / 4000 K) using »touchless control« or Occhio air.

* For a list of compatible dimmers, see www.occhio.com/dim_en, trailing-edge phasecut dimmer and Occhio air not combinable

Steuerung

Funktionen / Steuerungsmöglichkeiten der Leuchte einstellen.

Control

Set functions / control options of the luminaire.

Mito set box (standard)

Seite / page 11

Mito »air« box (optional)

Seite / page 21

Mito set box
(standard)

Mito set box (standard)

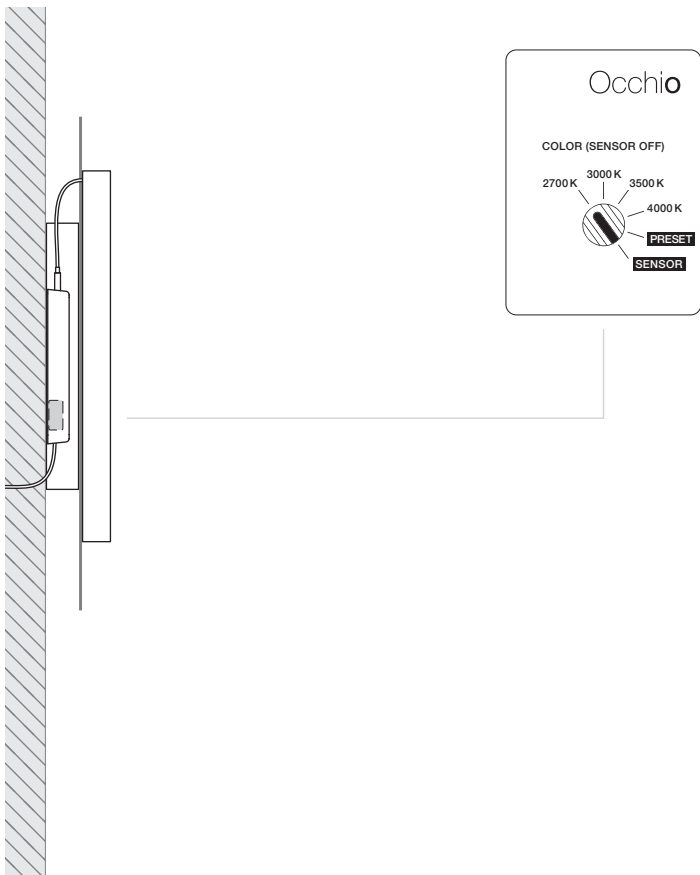



SENSOR = »touchless control« *

Gestensteuerung / gesture control (Seite / page 14)

- schalten / switching
- dimmen / dim
- color tune

PRESET = PRESET *

extern schalten / switch externally (Seite / page 16)

- Lichtintensität einstellbar (5 Stufen)
light intensity adjustable (5 stages)
- Farbtemperatur einstellbar (4 Stufen)
color temperature adjustable (4 stages)

COLOR (SENSOR OFF)

2700K 3000K 3500K 4000K = **color preset****

Farbtemperatur voreinstellbar, extern schalten und dimmen
color temperature pre-settable switch and dim externally
(Seite / page 18)

- extern schalten und dimmen
switch and dim externally

* **Nicht kombinierbar** mit einem externen
Phasenabschrittdimmer.

** **Kombinierbar** mit einem externen
Phasenabschrittdimmer.

* **Can not be combined** with an external
trailing-edge phasecut dimmer.

** **Can be combined** with an external
trailing-edge phasecut dimmer.

» touchless control «

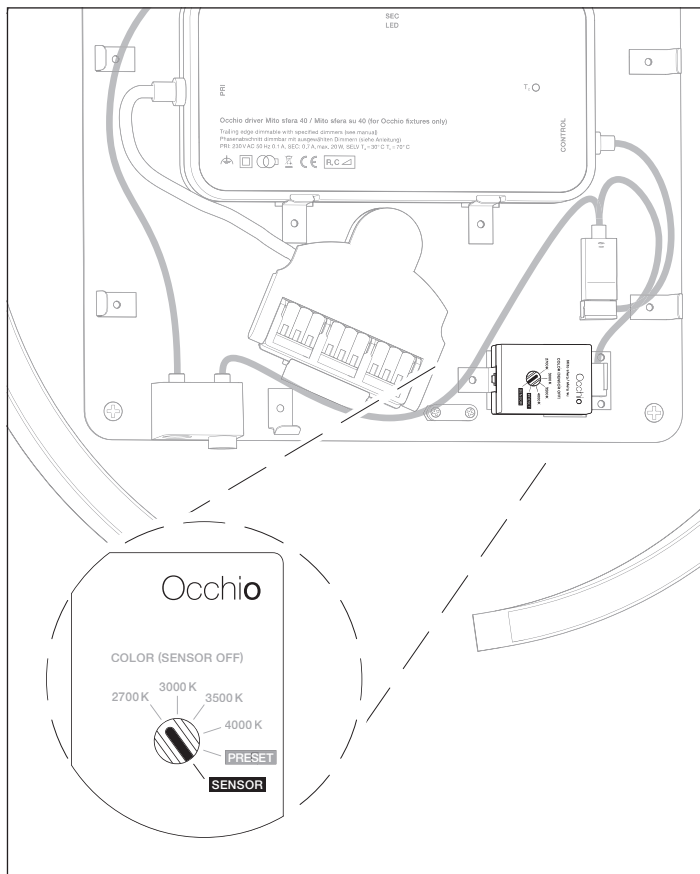

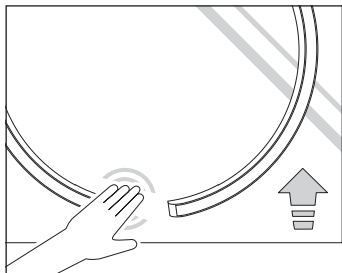

on/off

bewegen/move your hand

einstellbar an beiden Sensoren/adjustable on both sensors

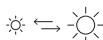
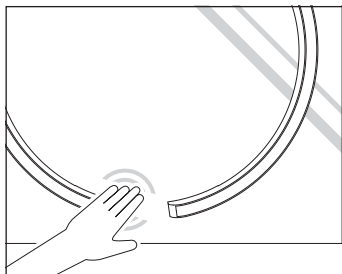

dimmen/dim

halten/keep your hand still

einstellbar an beiden Sensoren/adjustable on both sensors

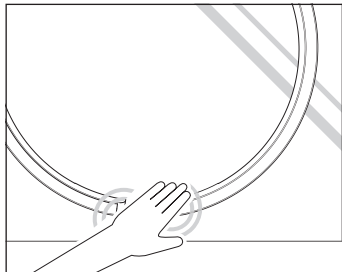

2700 K 4000 K

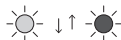

color tune

halten (beide Sensoren)

keep your hand still (both sensors)

Farbtemperatur stufenlos einstellen
sets color temperature continuously

PRESET

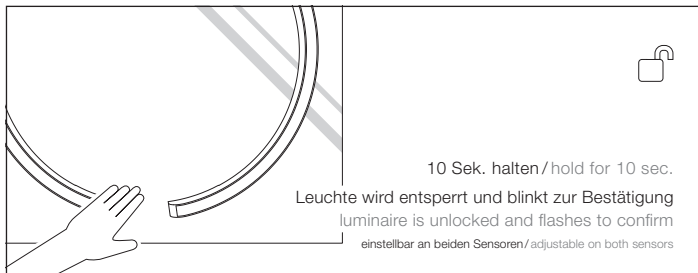
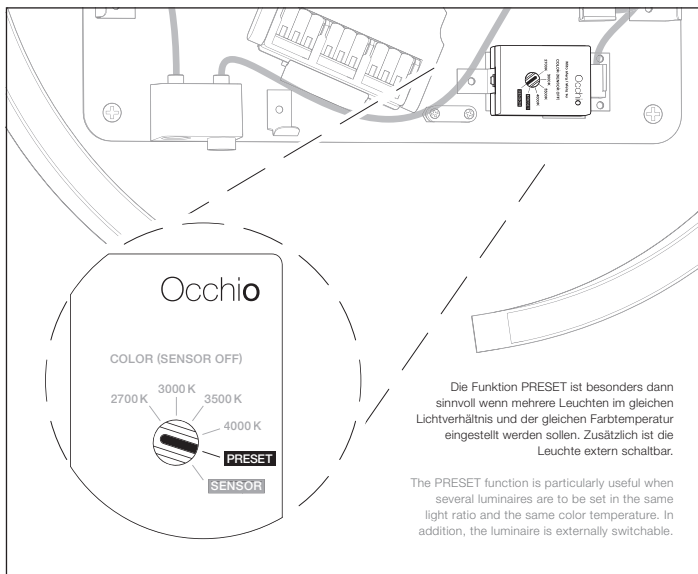

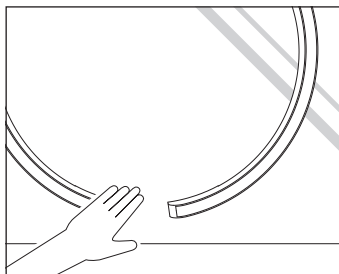

0 100



dimmen / dim

lange halten/keep your hand still for a time

Lichtverhältnis in 5 Stufen einstellen

sets the lighting conditions in 5 stages

einstellbar an beiden Sensoren/adjustable on both sensors

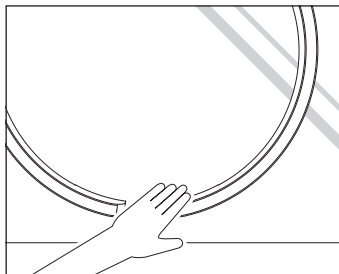

2700 K 3000 K 3500 K 4000 K



color tune

halten (beide Sensoren)

keep your hand still (both sensors)

Farbtemperatur in 4 Stufen einstellen

sets color temperature in 4 stages

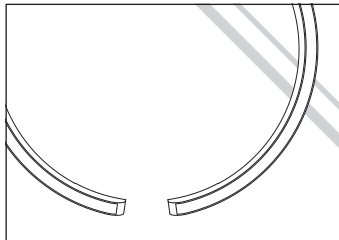

5 Min. warten oder
ausschalten, 10 Sek. warten, einschalten

wait for 5 min. or
switch off, wait 10 sec., switch on

Einstellung ist nun gespeichert

the setting is now saved

color preset (»touchless control« deaktiviert / »touchless control« deactivated)

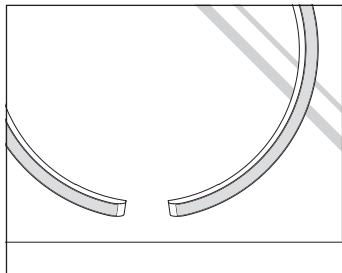
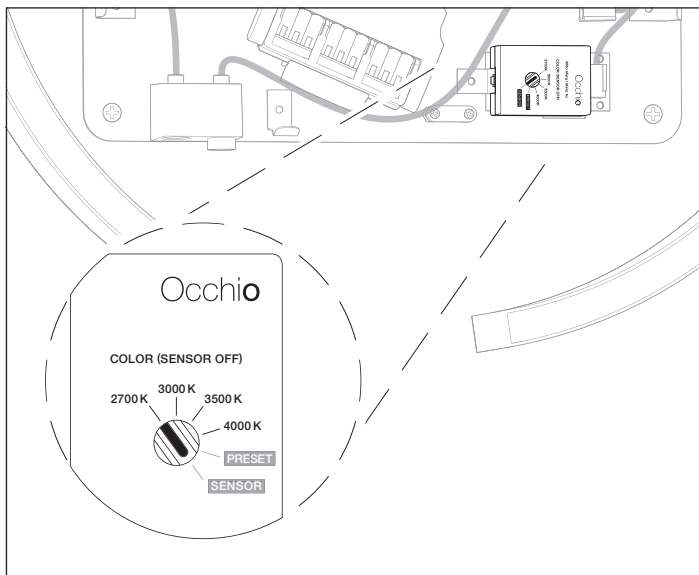

Farbtemperatur voreinstellbar
color temperature pre-settable
(2700 K, 3000 K, 3500 K, 4000 K)

»touchless control« **deaktiviert**
»touchless control« **deactivated**

phasenabschnitt dimmbar
trailing-edge phase cut dimmable



Mito »air« box
(optional)

Mito »air« box (optional)

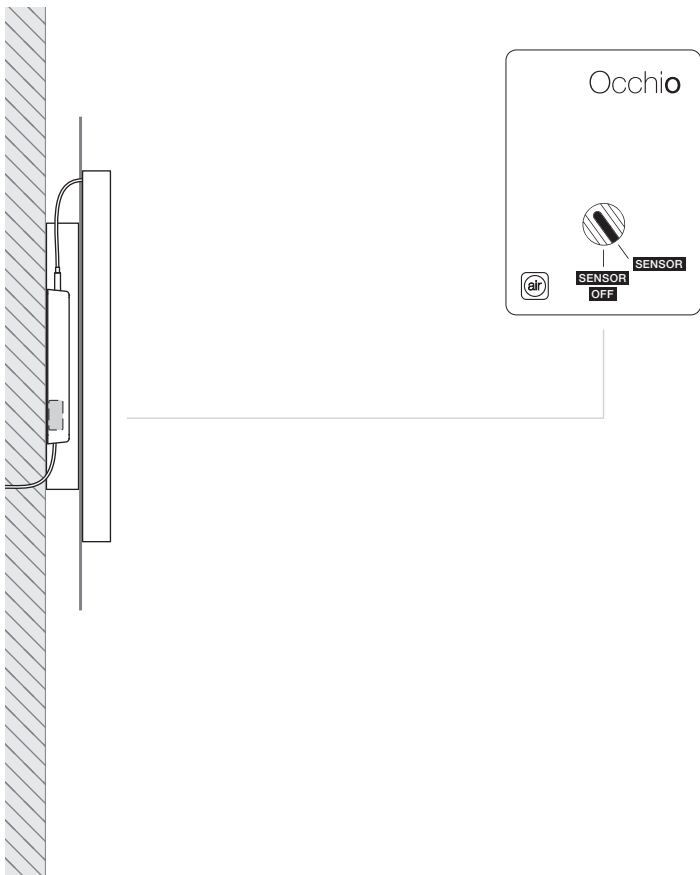



SENSOR = »touchless control« + »air«

Bluetooth- und Gestensteuerung / bluetooth and gesture control
(Seite / page 24)

- schalten / switching
- dimmen / dim
- color tune

SENSOR OFF = »air«

Bluetoothsteuerung / bluetooth control (Seite / page 26)

- schalten / switching
- dimmen / dim
- color tune

Nicht kombinierbar mit einem externen Phasenabschnittdimmer.

Can not be combined with an external trailing-edge phasecut dimmer.

» touchless control « + » air «

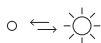
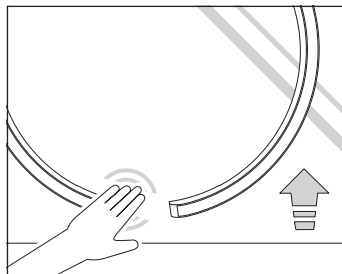
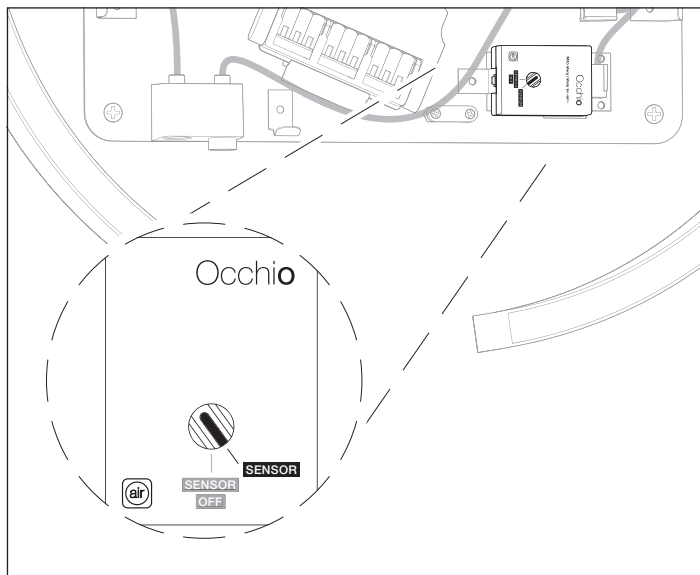

on/off

bewegen / move your hand

einstellbar an beiden Sensoren / adjustable on both sensors

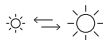
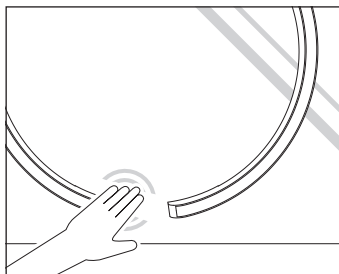

dimmen / dim

halten / keep your hand still

einstellbar an beiden Sensoren / adjustable on both sensors

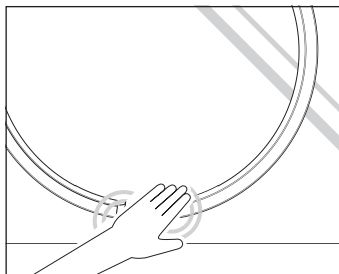

2700 K 4000 K

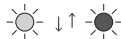

color tune

halten (beide Sensoren)

keep your hand still (both sensors)

Farbtemperatur stufenlos einstellen
sets color temperature continuously

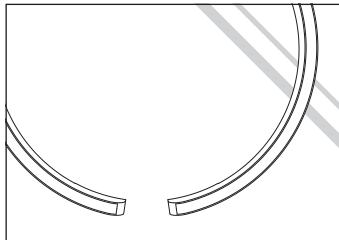

Steuerung via Occhio air, siehe Seite 65.

Control via Occhio air, see page 65.

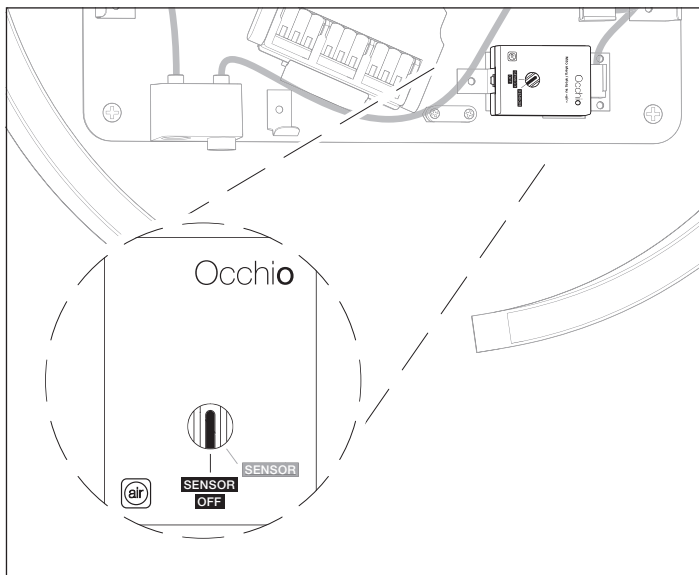



Vorbereitungen preparation

Kabelöffnung (Spiegel)

cable opening (mirror)

Mito sfera su 40



Abb. zeigt die empfohlene Ausrichtung der Leuchte.
Figure shows the recommended orientation of the luminaire.



**Spiegel wie abgebildet
vorbereiten, Bohrschablone
beachten!**

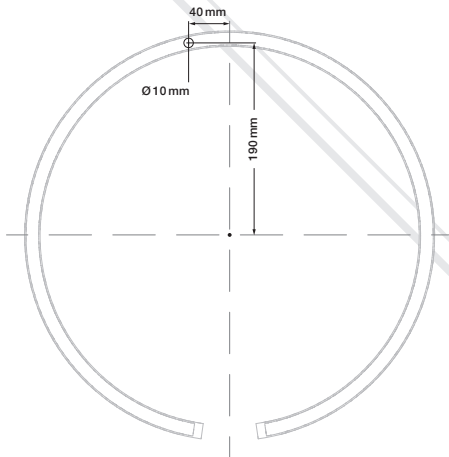

**Prepare the mirror
as shown, use drilling
template!**



Mito sfera su 60



Abb. zeigt die empfohlene Ausrichtung der Leuchte.
Figure shows the recommended orientation of the luminaire.



**Spiegel wie abgebildet
vorbereiten, Bohrschablone
beachten!**

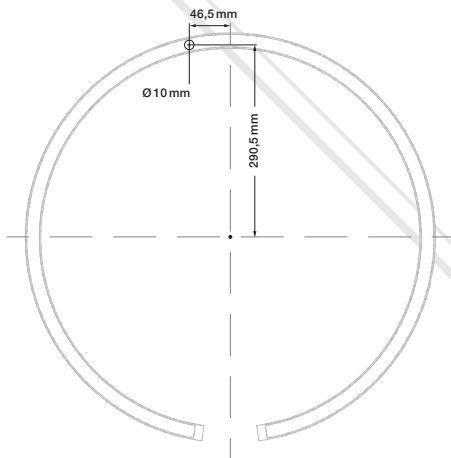

**Prepare the mirror
as shown, use drilling
template!**

Montage

Vorschaltgerät hinter dem
Spiegel

Mounting

power supply unit behind the
mirror

Montage (Vorschaltgerät hinter dem Spiegel)
Mounting (power supply unit behind the mirror)

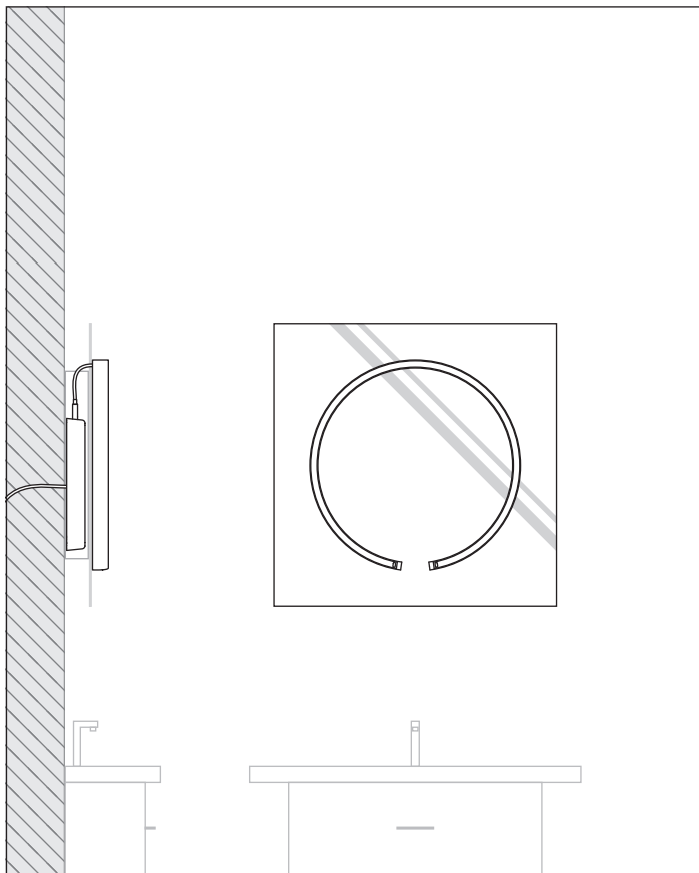

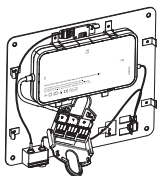

Vorschaltgerät
power supply unit



Mito sfera set box (vormontiert / pre-installed)



Mito sfera »air« box

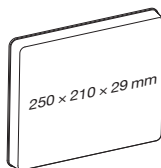

250 x 210 x 29 mm

Metallplättchen
metal plates

Spiegel*
mirror*

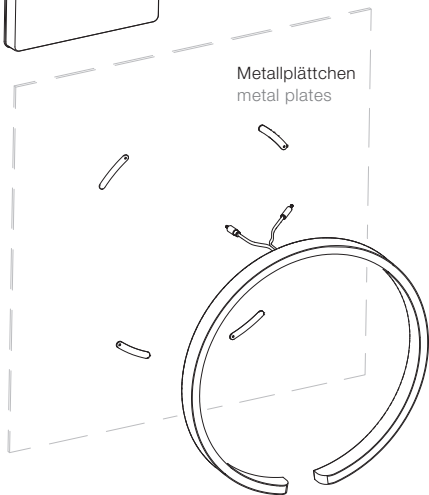

* nicht im Lieferumfang enthalten /
not included in the scope of supply

Mito sfera su 40/60

Montage (Vorschaltgerät hinter dem Spiegel) Mounting (power supply unit behind the mirror)

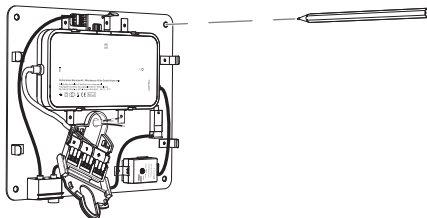

Achtung!
Vor der Montage alle
stromführenden Leitungen
vom Stromnetz trennen!



Caution!
Before mounting, disconnect
all currentcarrying lines from
the mains supply!



x



e

ø

ø 6 mm

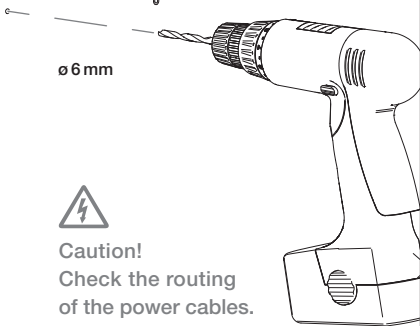

Achtung!
Auf den Verlauf von
Stromleitungen achten!



Caution!
Check the routing
of the power cables.

Montage (Vorschaltgerät hinter dem Spiegel) Mounting (power supply unit behind the mirror)

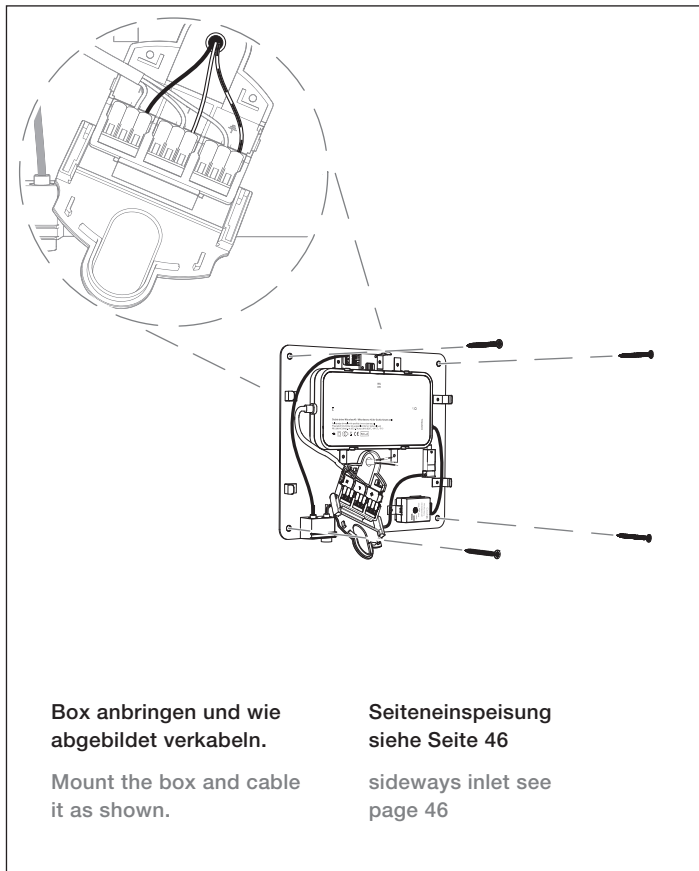

**Box anbringen und wie
abgebildet verkabeln.**

Mount the box and cable
it as shown.

**Seiteneinspeisung
siehe Seite 46**

sideways inlet see
page 46



min. 30 mm

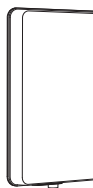

**Geeignete Unterkonstruktion erstellen
und Spiegel anbringen (muss abnehmbar
bleiben).**

Create a suitable substructure and attach
the mirror (must remain removable).

Montage (Vorschaltgerät hinter dem Spiegel)
Mounting (power supply unit behind the mirror)

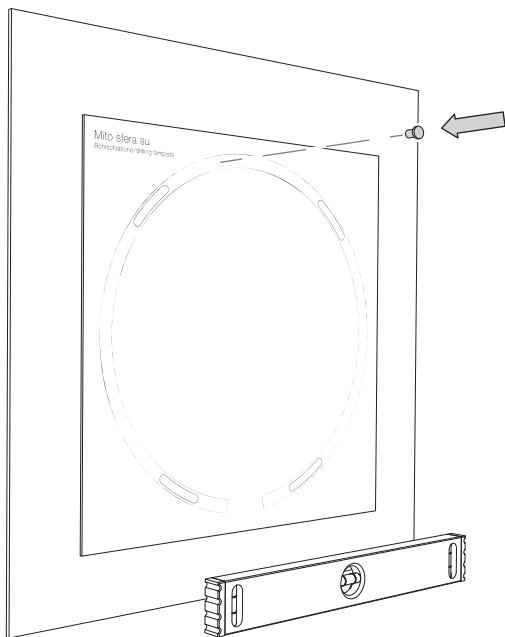

**Bohrschablone an der Boh-
rung anlegen und mit einer
Wasserwaage ausrichten.**

**Place the drilling template
on the hole and align it with
a spirit level.**

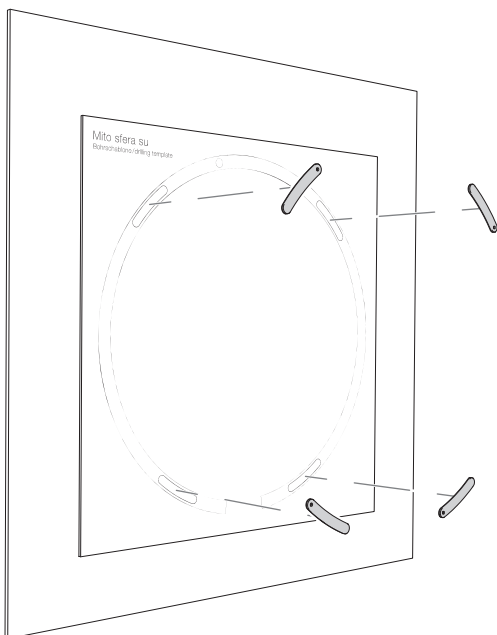

**Metallplättchen in die
Aussparungen kleben.**

**Glue metal plates in
recesses.**

Montage (Vorschaltgerät hinter dem Spiegel)
Mounting (power supply unit behind the mirror)

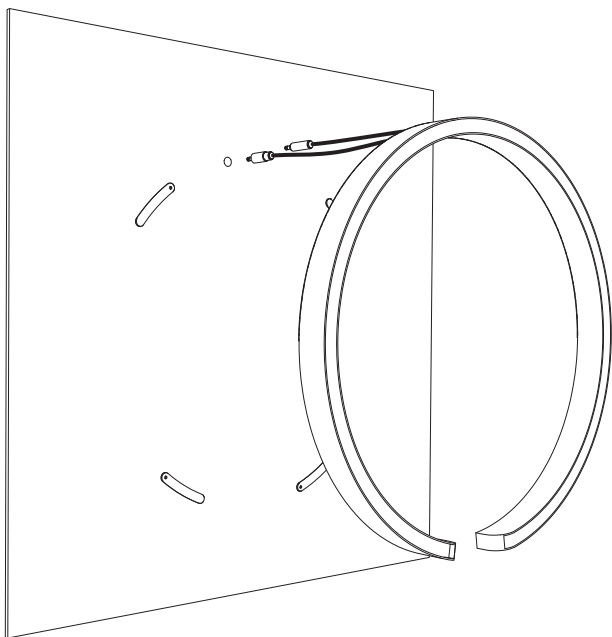

Kabel einzeln durch die Bohrung führen und Leuchte auf Metallplättchen klinken.

Lead the cable individually through the hole and clip the luminaire onto the metal plates.

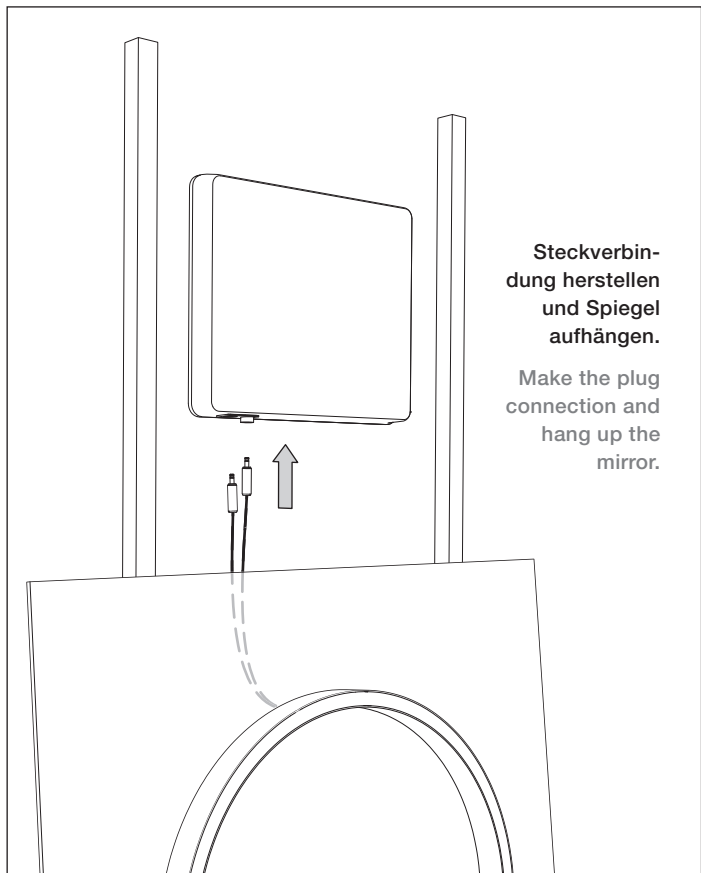

**Steckverbindung herstellen
und Spiegel
aufhängen.**

**Make the plug
connection and
hang up the
mirror.**

Montage (Vorschaltgerät hinter dem Spiegel)
Mounting (power supply unit behind the mirror)

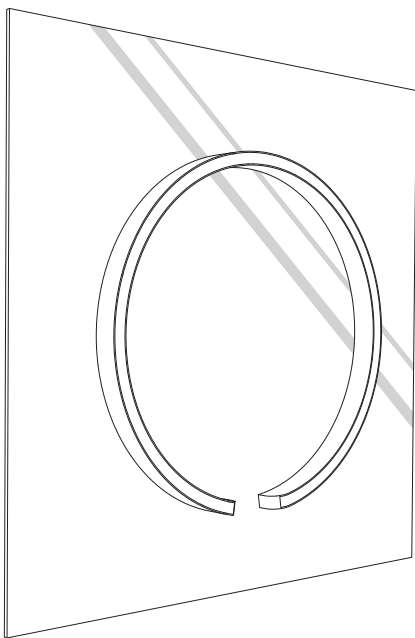

**Die Leuchte ist nun fertig
montiert.**

**The luminaire is now
completely mounted.**



Seiteneinspeisung (optional) sideways inlet (optional)

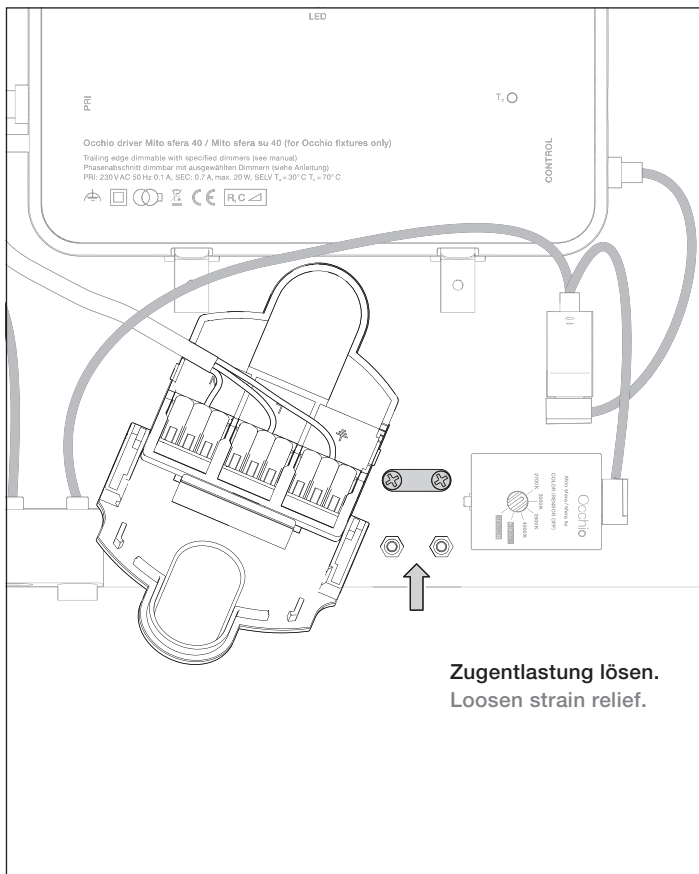

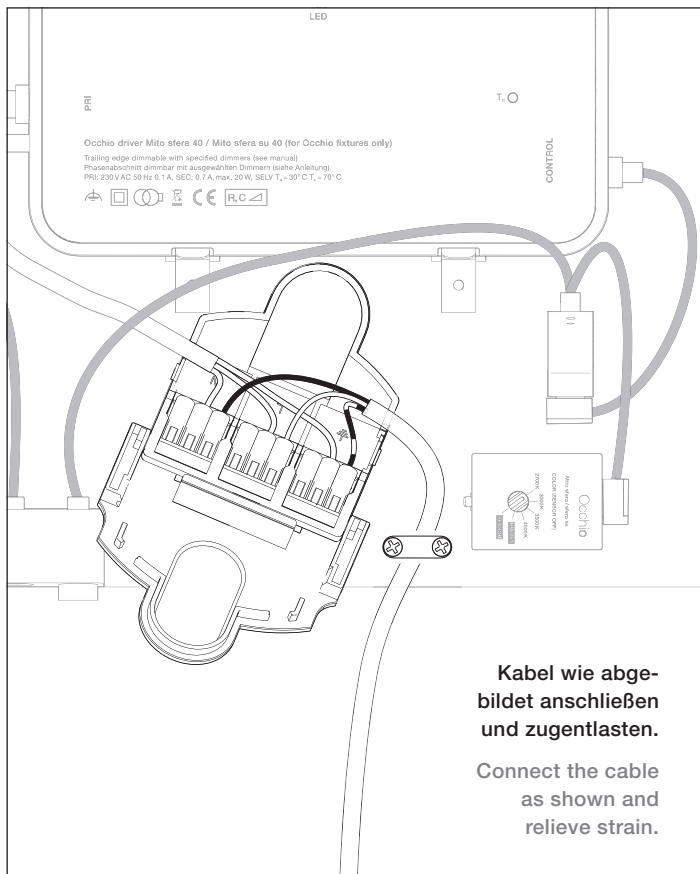

Montage

Vorschaltgerät in Revision

Mounting

power supply unit in revision

Montage (Vorschaltgerät in Revision) Mounting (power supply unit in revision)

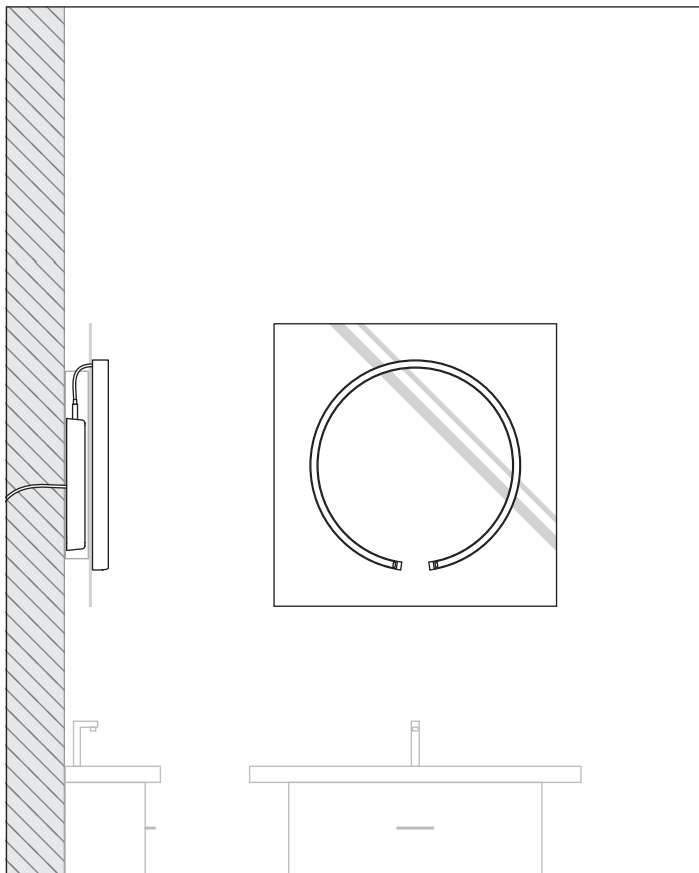

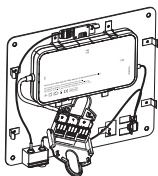

Vorschaltgerät
power supply unit



Mito sfera set box (vormontiert / pre-installed)



Mito sfera »air« box

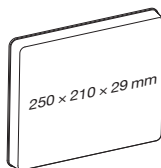

250 x 210 x 29 mm

Metallplättchen
metal plates

Spiegel*
mirror*

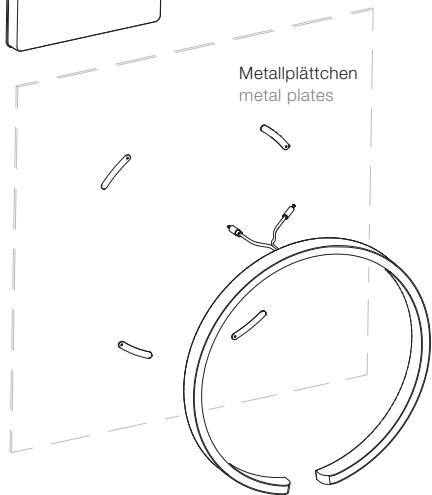

* nicht im Lieferumfang enthalten /
not included in the scope of supply

Mito sfera su 40/60

Montage (Vorschaltgerät in Revision) Mounting (power supply unit in revision)

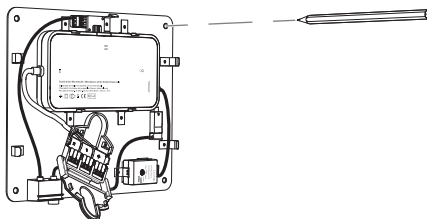

Achtung!
Vor der Montage alle
stromführenden Leitungen
vom Stromnetz trennen!



Caution!
Before mounting, disconnect
all currentcarrying lines from
the mains supply!



x



c

ø

ø 6 mm

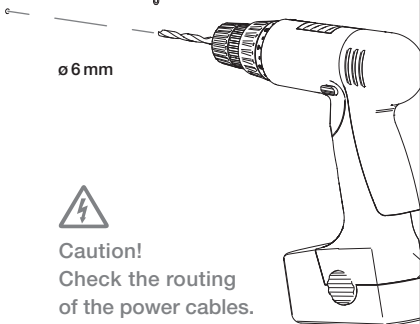

Achtung!
Auf den Verlauf von
Stromleitungen achten!



Caution!
Check the routing
of the power cables.

Montage (Vorschaltgerät in Revision) Mounting (power supply unit in revision)

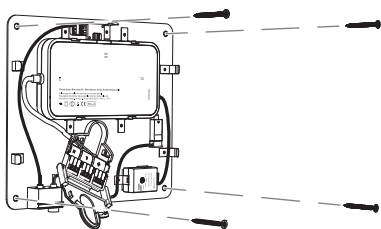

Box anbringen.
Mount the box.

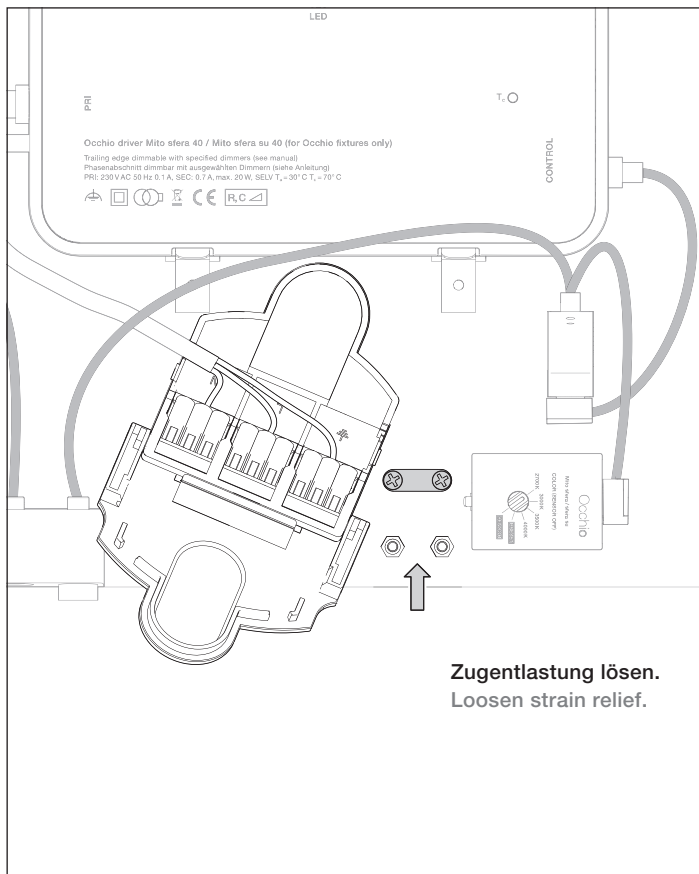

Zugentlastung lösen.
Loosen strain relief.

Montage (Vorschaltgerät in Revision) Mounting (power supply unit in revision)

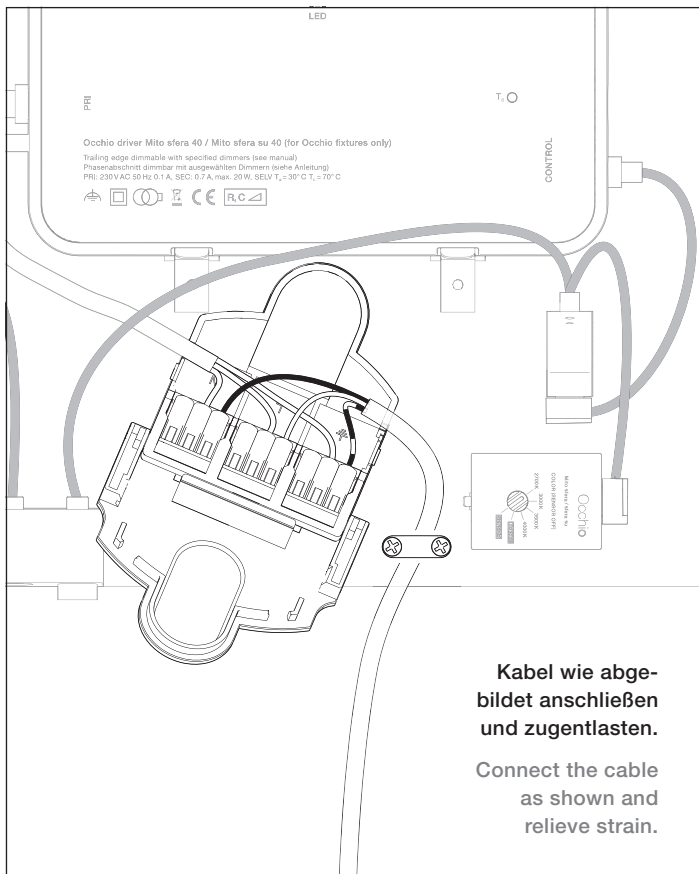

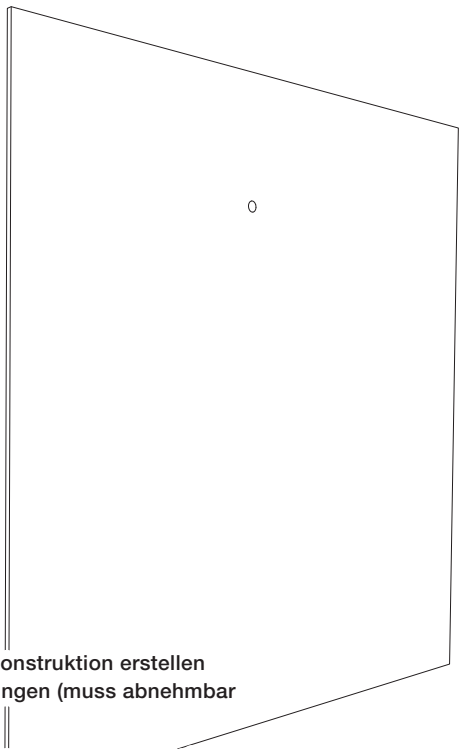

**Geeignete Unterkonstruktion erstellen
und Spiegel anbringen (muss abnehmbar
bleiben).**

Create a suitable substructure and attach
the mirror (must remain removable).

Montage (Vorschaltgerät in Revision) Mounting (power supply unit in revision)

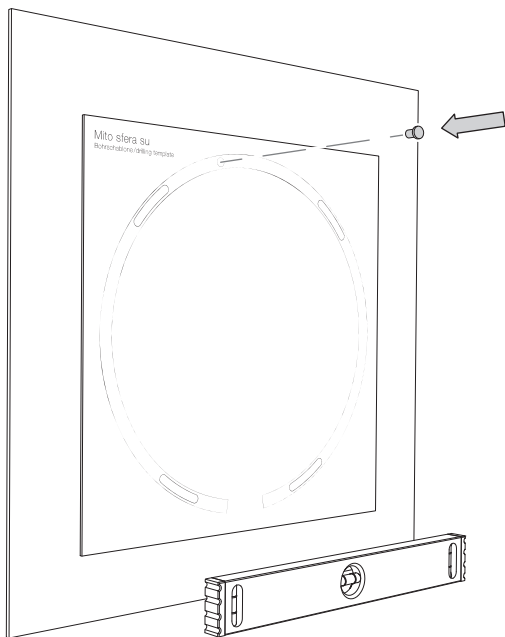

**Bohrschablone an der Boh-
rung anlegen und mit einer
Wasserwaage ausrichten.**

**Place the drilling template
on the hole and align it with
a spirit level.**

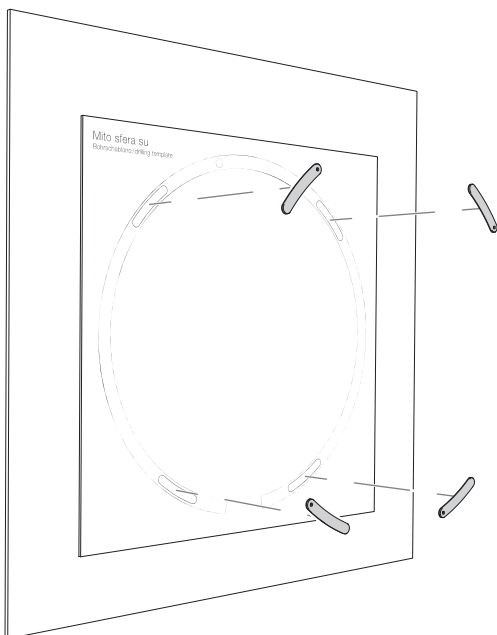

**Metallplättchen in die
Aussparungen kleben.**

**Glue metal plates in
recesses.**

Montage (Vorschaltgerät in Revision)
Mounting (power supply unit in revision)

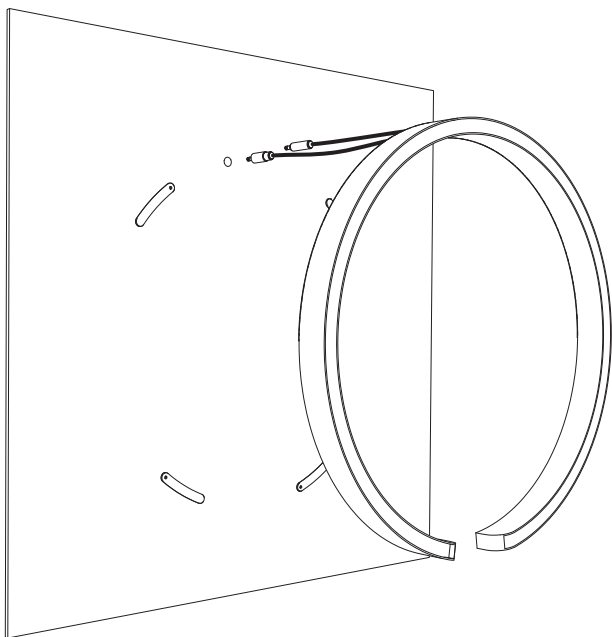

Kabel einzeln durch die Bohrung führen und Leuchte auf Metallplättchen klipsen.

Lead the cable individually through the hole and clip the luminaire onto the metal plates.



**Leuchtenkabel
wie abgebildet
verbinden.**

**Connect luminaire
cable as shown.**

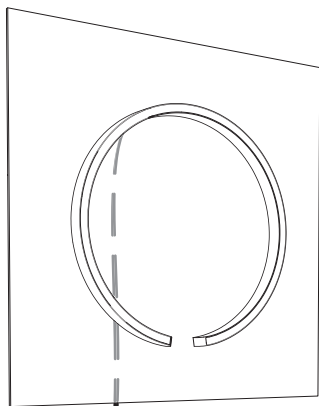

Leuchtenkabel
luminaire cable

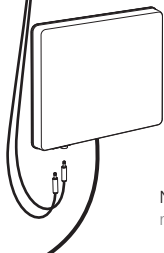

Netzkabel
mains cable

Montage (Vorschaltgerät in Revision) Mounting (power supply unit in revision)

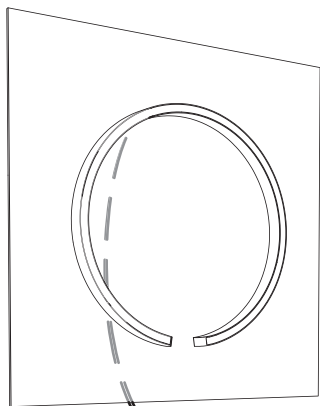

Leuchtenkabel
luminaire cable

Falls das Leuchtenkabel
nicht ausreicht (1,2 m),
steht ein Verlängerungs-
kabel (optional) mit 5 m
zur Verfügung.

If the luminaire cable
is not sufficient (1.2 m),
an extension cable
(optional) with 5 m
is available.

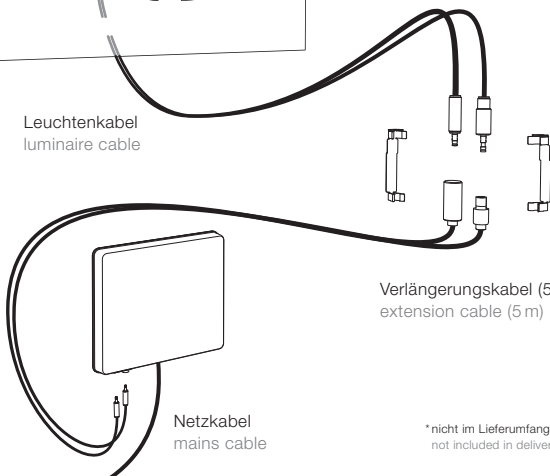

Verlängerungskabel (5 m)*
extension cable (5 m)

Netzgerät
mains cable

* nicht im Lieferumfang enthalten
not included in delivery

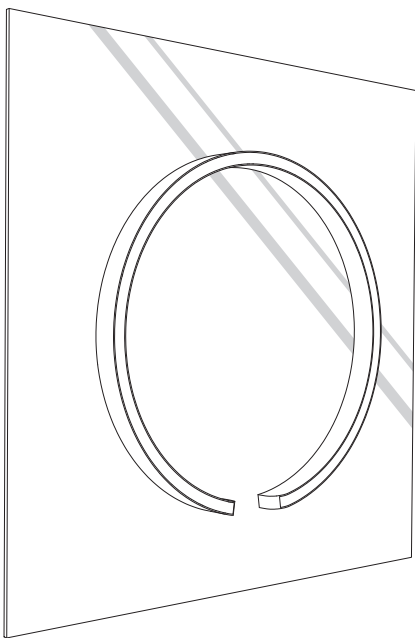

**Die Leuchte ist nun fertig
montiert.**

**The luminaire is now
completely mounted.**

Steuerung mit
der Occhio air
App (optional)

Control using
the Occhio air
app (optional)

Steuerung mit der Occhio air App (optional)

Control using the Occhio air app (optional)

Quick guide

Die Occhio air Produkte lassen sich mit der Occhio air App einrichten und steuern.

App installieren, App öffnen und angeschlossene Leuchten einrichten.

Occhio air products can be set up and controlled using the Occhio air app.

Install App, open App and set up connected luminaires.



Occhio air tutorials

www.occhio.com/air-tutorials

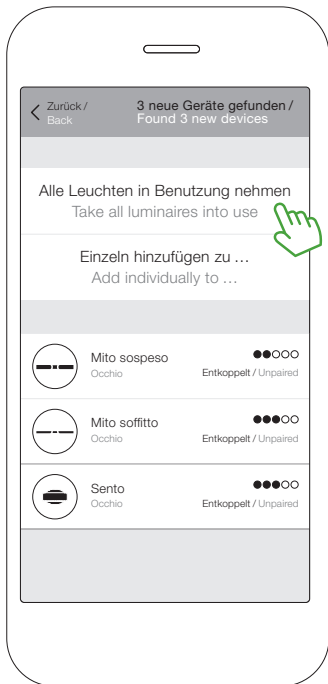

Ein Netzwerk (mein Netzwerk) wird autom. erstellt.

A network (my network) is autom. created.

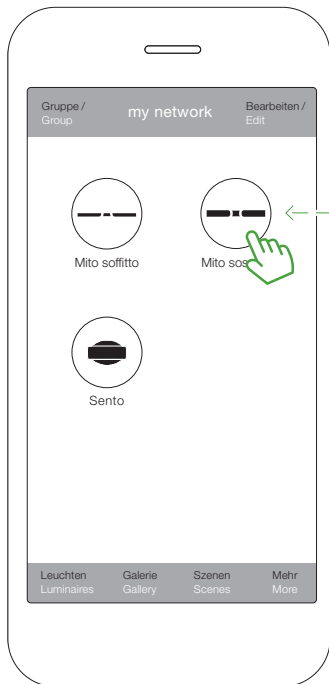

Steuerungsgesten Control gestures

on / off
on / off



antippen
tap

dimmen
dim



wischen
swipe

up / down
faden *



wischen
swipe

color tune **
magic move ***



halten
hold



wischen
swipe

Nur bei Leuchten mit beidseitigem Lichtaustritt *,
color tune ** oder magic move ***

Only for luminaires with double-sided light output *,
color tune ** or magic move ***

Und so werden die Leuchten gesteuert.
And so the luminaires are controlled.

Steuerung mit der Occhio air App (optional) Control using the Occhio air app (optional)

Nutzung auf mehreren Geräten

Use on several devices

Optional können Sie nun ihr
erstelltes Netzwerk (mein
Netzwerk) mit Anderen teilen.

Optionally, you can now share
your created network (my
network) with others.

1. Netzwerknamen
vergeben

1. Assign name

Occhio air tutorials

www.occhio.com/air-tutorials

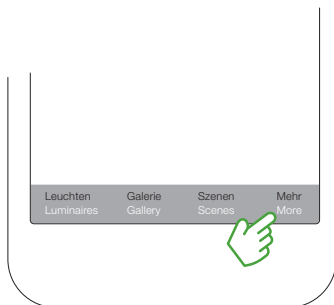

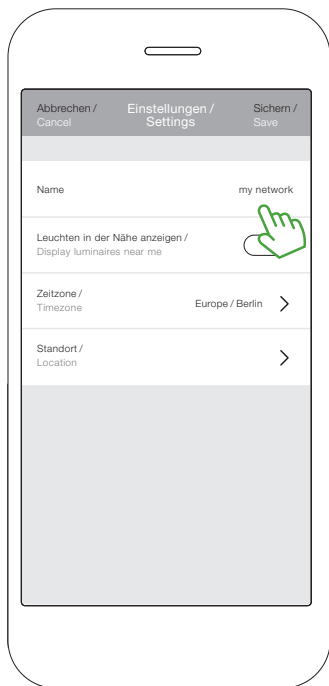

Netzwerkconfiguration → Netzwerkeinstellungen → Namen eingeben → Sichern
Network setup → Network settings → enter name → save

Steuerung mit der Occhio air App (optional) Control using the Occhio air app (optional)

Netzwerk freigeben
und schützen

Share and protect the
network

Occhio air tutorials

www.occhio.com/air-tutorials

2. Netzwerk
freigeben

2. Share network

Leuchten Luminaires	Galerie Gallery	Szenen Scenes	Mehr More
------------------------	--------------------	------------------	--------------



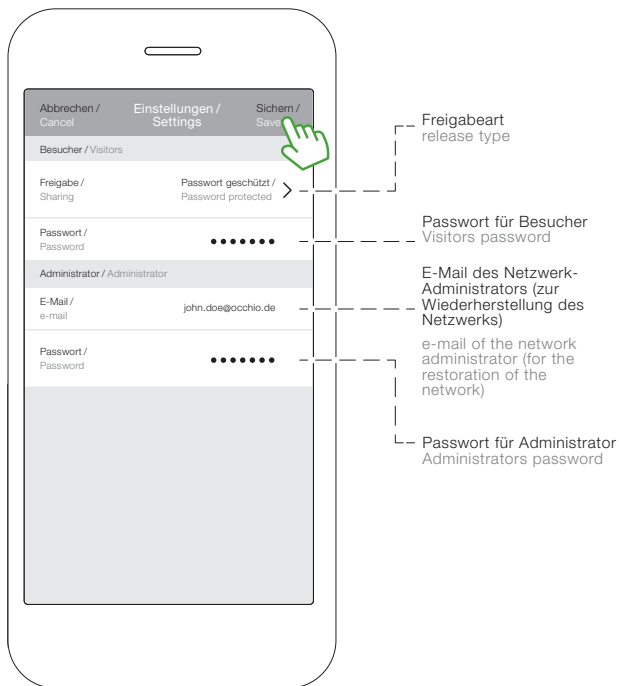

Netzwerkconfiguration → Freigabe-
optionen → Passwort geschützt → Sichern
Network setup → Sharing settings →
Password protected → save

Steuerung mit
dem Occhio air
controller
(optional)

Control using
the Occhio air
controller
(optional)

Steuerung mit dem Occhio air controller (optional) Control using the Occhio air controller (optional)

Occhio air controller

Intuitiv bedienbare Fernbedienung mit vier programmierbaren Tasten (Einrichtung via Occhio air App). Unabhängig von der App können einzelne Leuchten, Gruppen und Szenen gesteuert werden. Optional mit Wandhalterung erhältlich.

Maximaler Bedienkomfort und umfassende Steuerung via Bluetooth 4.0 (Bluetooth Low Energy). Schalten, dimmen, faden, color tune von einzelnen Leuchten, Gruppen und Szenen.

Occhio air controller

Intuitive remote control with four programmable buttons (setup via Occhio air app). Individual luminaires, groups and scenes can be controlled regardless of the app. Available with optional wall mount.

Maximum ease of use and total control via Bluetooth 4.0 (Bluetooth low energy). Switching, dimming, fading, color tune of individual luminaires, groups and scenes.



Zum Einrichten des Occhio air controllers wird die Occhio air App benötigt. Eine Video-Kurzanleitung kann unter: www.occhio.com/air-tutorials aufgerufen werden.

To set up the Occhio air controller, the Occhio air app is required. A video quick start guide can be called up at www.occhio.com/air-tutorials.

schalten/switch



⏏ - ☰ einzelne Leuchten, Gruppen, oder Szenen schalten

⏏ - ☰ switch individual luminaires, groups or scenes

dimmen/dim



⊕ - ☰ einzelne Leuchten, Gruppen, oder Szenen dimmen

⊕ - ☰ dims individual luminaires, groups or scenes

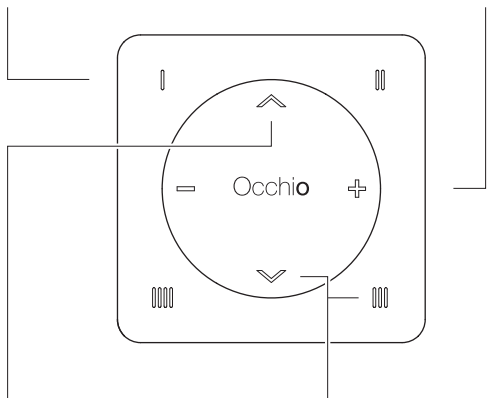

faden*



⤴ ⤵ einzelne Leuchten, Gruppen oder Szenen faden (up/down Verhältnis ändern)

⤴ ⤵ fades individual luminaires, groups or scenes (change up/down relation)

color tune**

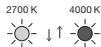

⏏ - ☰ and ⤴ ⤵ Farbtemperatur einzelner Leuchten, Gruppen oder Szenen einstellen

⏏ - ☰ and ⤴ ⤵ adjust color temperature of individual luminaires, groups or scenes

* Leuchten mit beidseitigem Lichtaustritt / luminaires with light emission on both sides ** Mito

Anhang

Appendix

Pflegehinweise

Care instructions

Leuchte nur in abgekühltem Zustand reinigen! Zur Reinigung der Leuchte ein trockenes Mikrofasertuch verwenden. Detaillierte Pflegehinweise sind unter www.occhio.com/de/company/faq zu finden.

Always allow the luminaire to cool down before cleaning! To clean the luminaire, use a dry microfibre cloth. Detailed care instructions are available at www.occhio.com/en/company/faq.

Info & Kontakt

Information & contact





Weitere Fragen beantwortet gerne
Ihr Occhio Fachhändler

Your Occhio specialist retailer will
gladly answer any other questions

www.occhio.com
info@occhio.com

Technische Daten

Technische Daten Leuchte

Artikelbezeichnung	Mito sfera su 40, Mito sfera su 60
Abmessungen	ø head 400 mm, ø head 600 mm H 30 mm
Schutzklasse	2
Anschluss	230 VAC
Dimmung	via Phasenabschnittdimmer, »touchless control« oder Occhio air (Liste kompatibler Dimmer: www.occhio.com/dim , Phasenabschnittdimmer und Occhio air sind nicht kombinierbar)
Material	Aluminium lackiert oder PVD-beschichtet, optisches Silikon
LED-Leistung	Mito sfera su 40: 20 W Mito sfera su 60: 40 W
Zulässige Betriebsbedingung	max. 30°C nur im Innenbereich betreiben
Prüfzeichen	IP44 CE    

Technische Daten Leuchtmittel



Leuchtmittel	Occhio »color tune« LED
Ausführung	LED-board
Lebensdauer	> 50.000 Std.

Entsorgung

Bei örtlicher Entsorgungsstelle entsorgen. Mito sfera su ist recyclebar; RoHS-konform. **Nicht in den Hausmüll geben!**

Technical data

Technical data luminaire

Product designation	Mito sfera su 40, Mito sfera su 60
Dimensions	ø head 400 mm, ø head 600 mm H 30 mm
Safety class	2
Connection	230 V AC
Dimming	via trailing-edge phasecut dimmer, »touchless control« or Occhio air (For a list of compatible dimmers, see www.occhio.com/dim_en , trailing-edge phasecut dim- mer can not be combined with Occhio air)
Material	aluminium painted or PVD-coated, optical silicone
LED power	Mito sfera su 40: 20 W Mito sfera su 60: 40 W
Permitted operating conditions	max. 30°C for indoor use only
Test symbols	IP44 CE F   

Technical data light source

Light source	Occhio »color tune« LED
Version	LED-board
Lifetime	> 50.000 h

Disposal

Dispose of at a local disposal site. Mito sfera su is recyclable and RoHS compliant. **Do not dispose of with the household waste!**

Occhio

www.occhio.com



010405944518998210