

ASTERIA TABLE

Designed by Søren Ravn Christensen

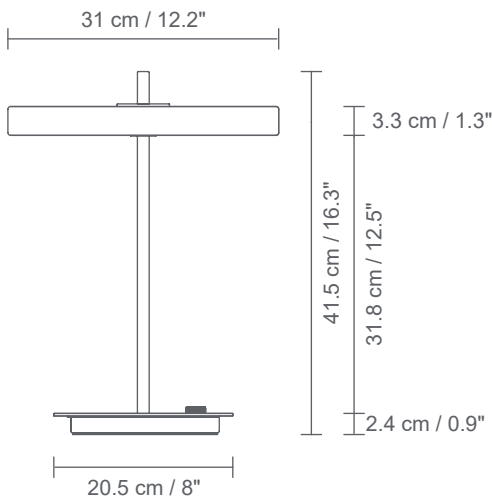



 Table lamp

 **TESTS & CERTIFICATIONS**
CE (for indoor use), IP2X, cETLuscertified

 USB-port incl.

 **DIMENSIONS**
Ø: 31 cm / 12.2"
H: 41.5 cm / 16.3"

 **MATERIAL**
Polypropylene, steel, aluminium and acrylic
Incl. 2 m / 6'6" black cord

 **WARRANTY**
10 years warranty against manufacturer defects

 **WEIGHT INCL. PACKAGING**
3.1 kg / 6.8 lb

 **LIGHT SOURCE**
13W LED panel built-in. 3000 K - 600 lumen CRI: 83
25000 H. Dimmable

 **PACKAGING**
Gift box dimensions (L × W × H):
33.6 × 54.6 × 5.6 cm / 13.2 × 21.5 × 2.2"

 **ASSEMBLY TIME**
5 min - video guide at umage.com

 **MEDIA KIT**
Photos and press material
Download at umage.presscloud.com

 **ORDERING INFORMATION**
Pearl white
Anthracite grey
Forest green
Ruby red
Black
Nuance mist
Nuance olive
Nuance rose
Nuance orange

Colour variations

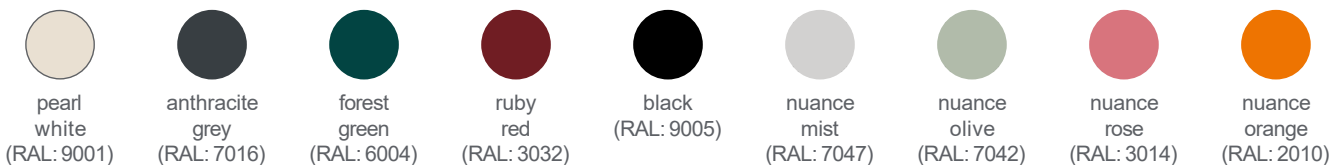

UMAGE