

TITANIA

design Alberto Meda / Paolo Rizzatto

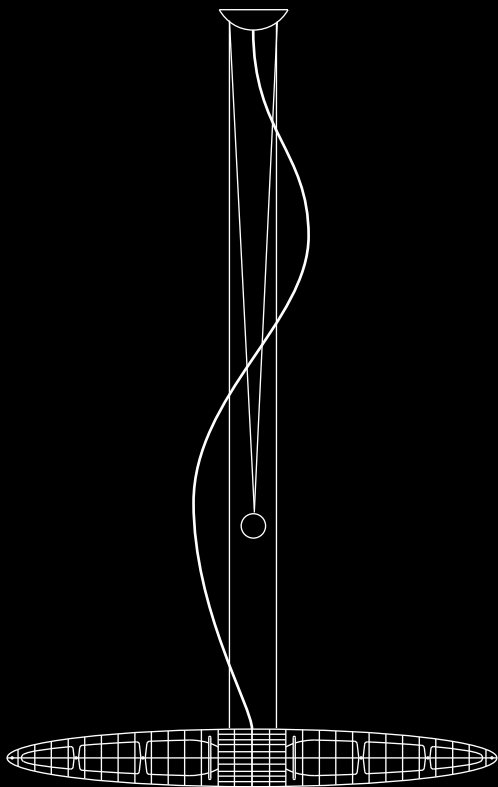

**LUCE
PLAN**

D17



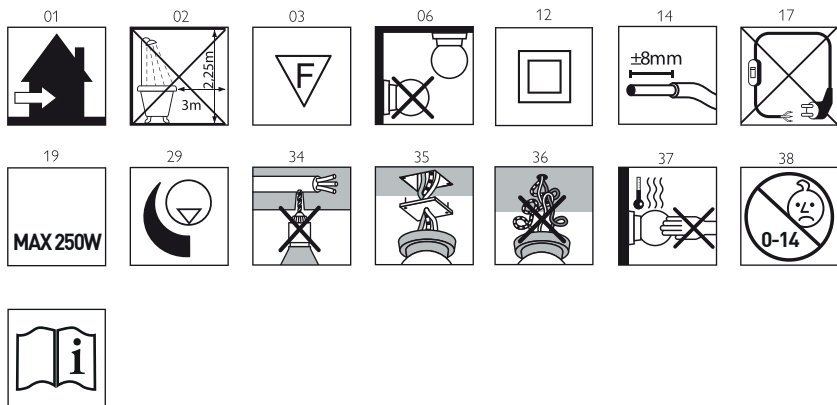

D17



a



b

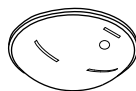
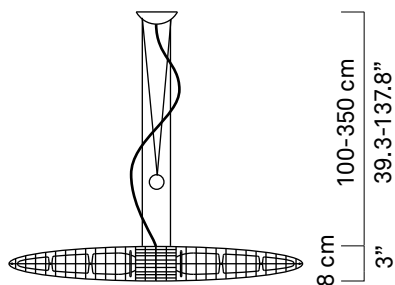

x1



x1

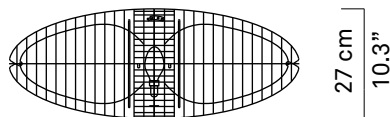

x2



x1

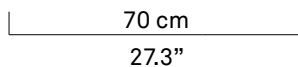

x1



x1

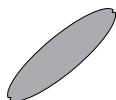

x10

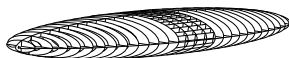

x1



x1

kg 1,3 kg

lb 2.9 lb



max 250W
E27



205W
HSGST/F
E27
energy saver



23W
FBT
E27
h max 12 cm - 4.8"
ø 4,5 cm - 1.8"

D13/25

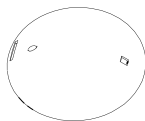

x1

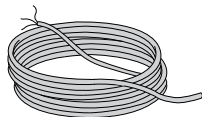

x1

(300 cm - 118")

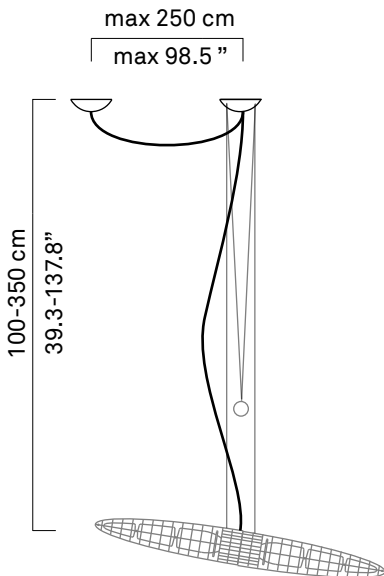

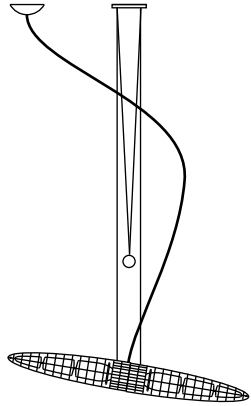
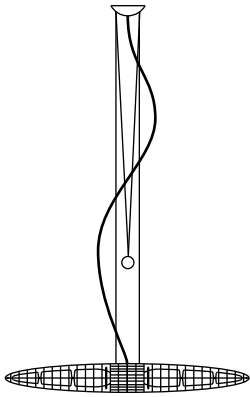

D17 + D13/25

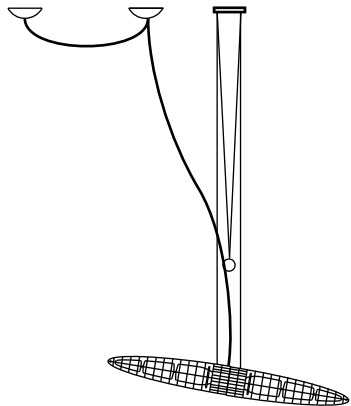
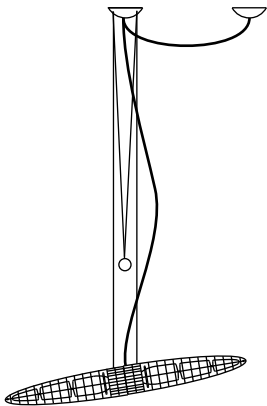

1

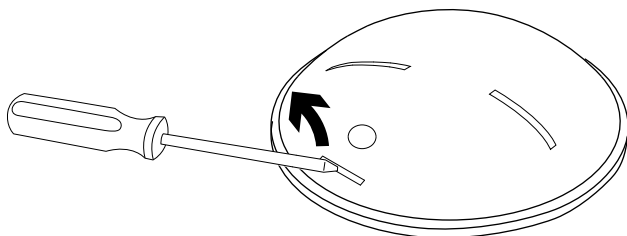

1.1

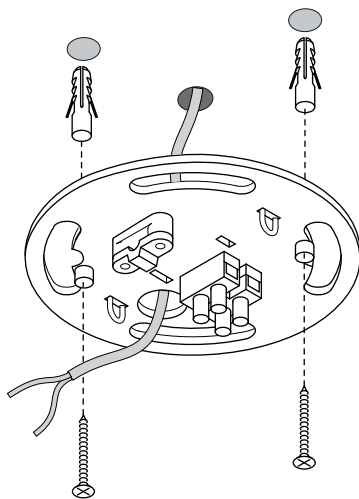
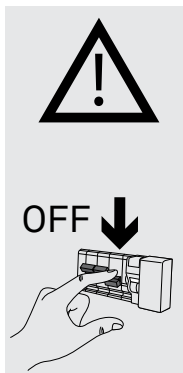

1.2

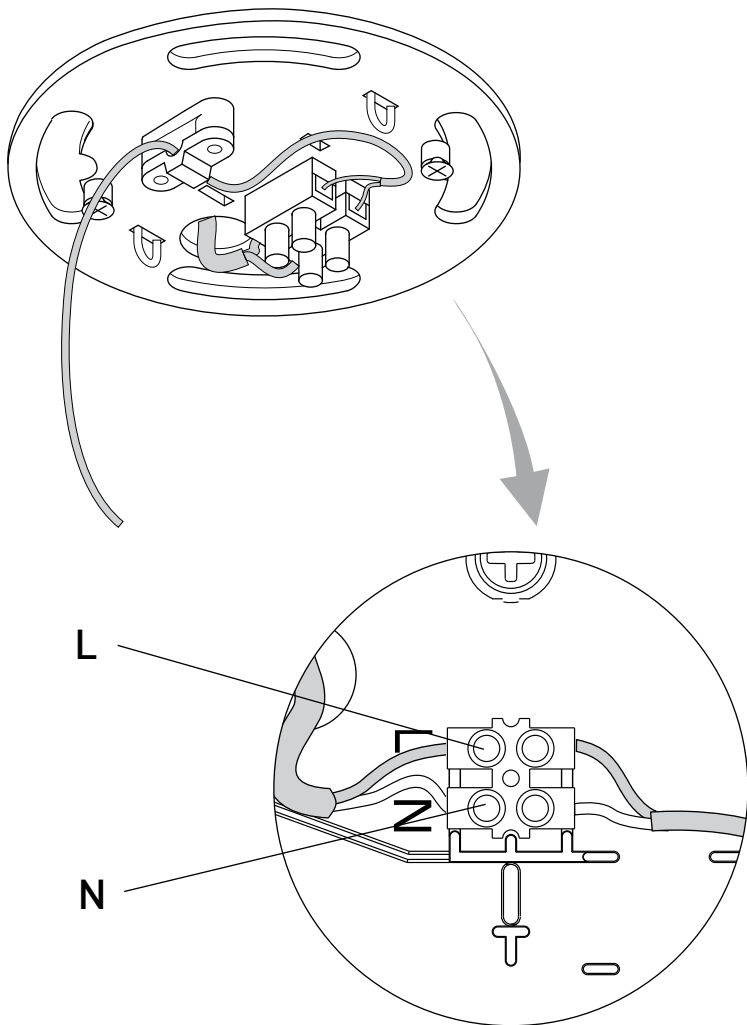

2

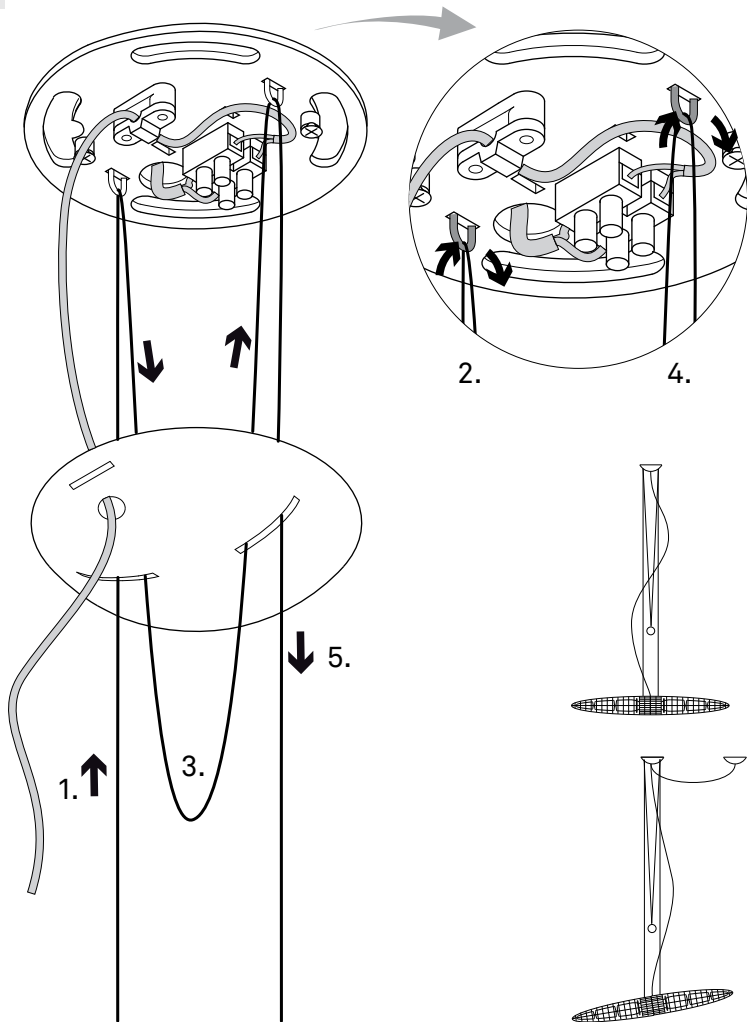

2.1

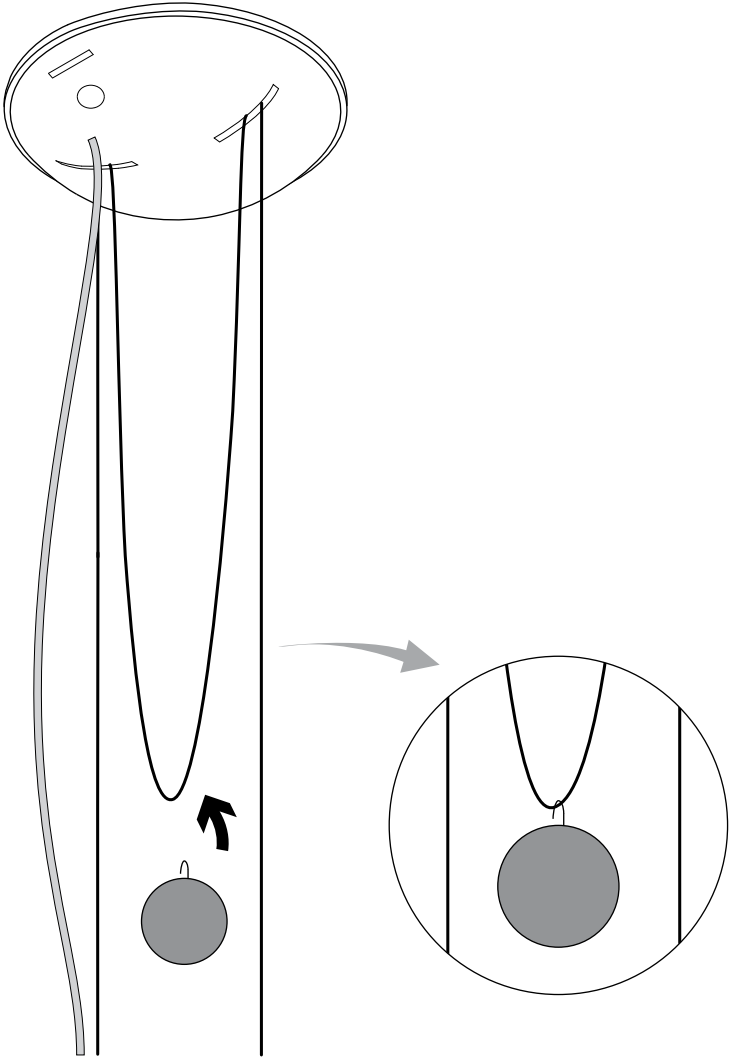

3

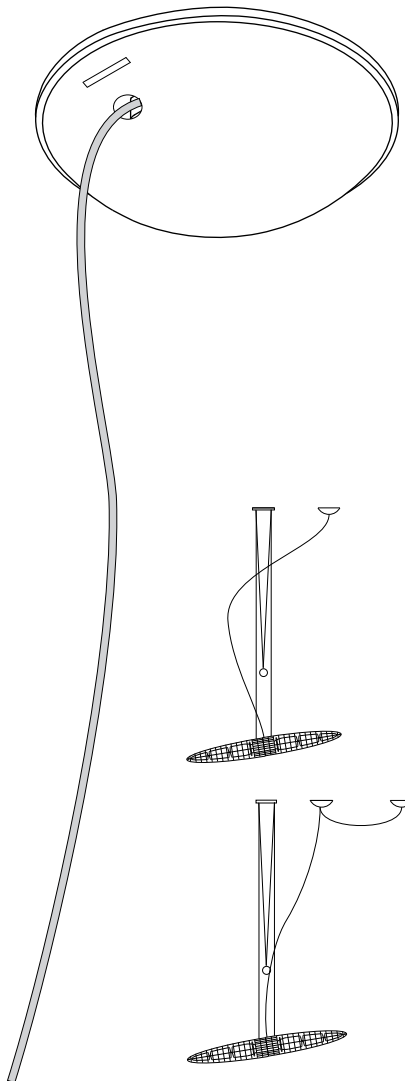
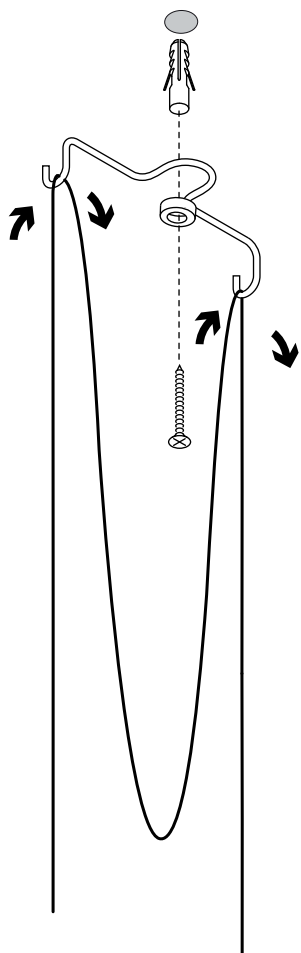

3.1

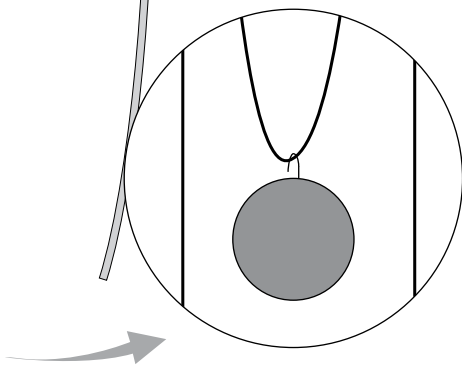
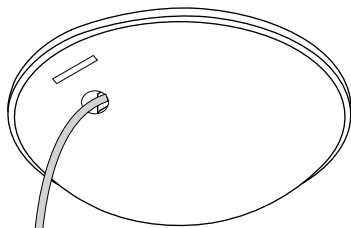
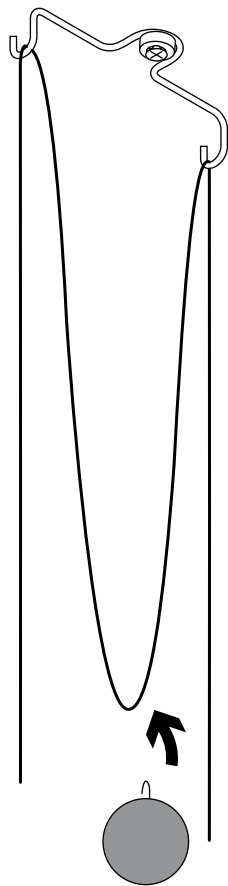

4 x2

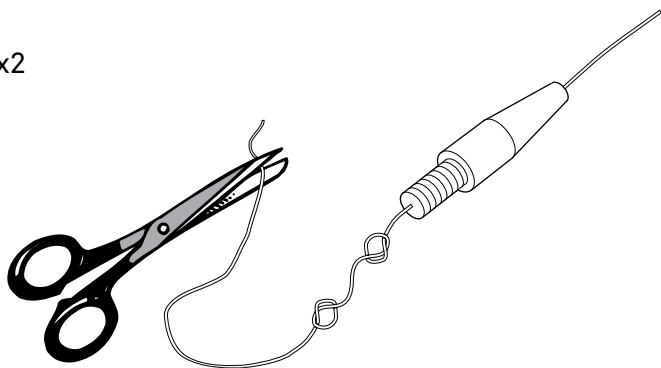

4.1

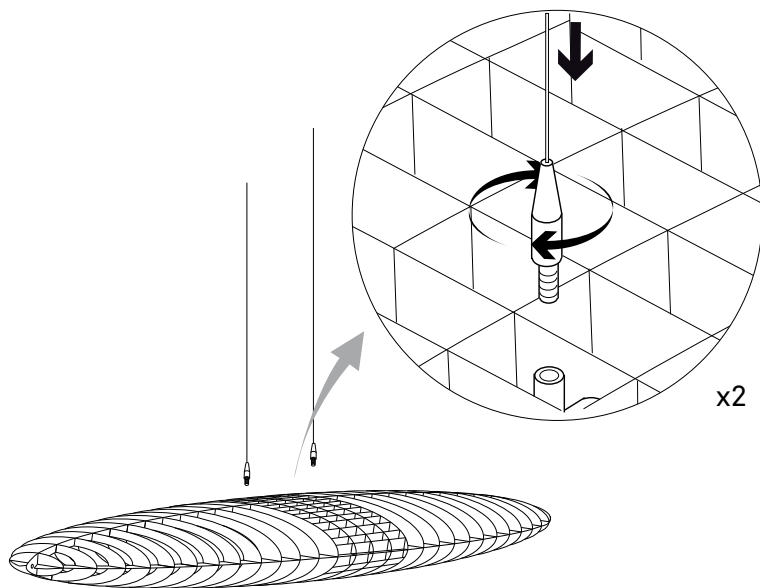

4.2

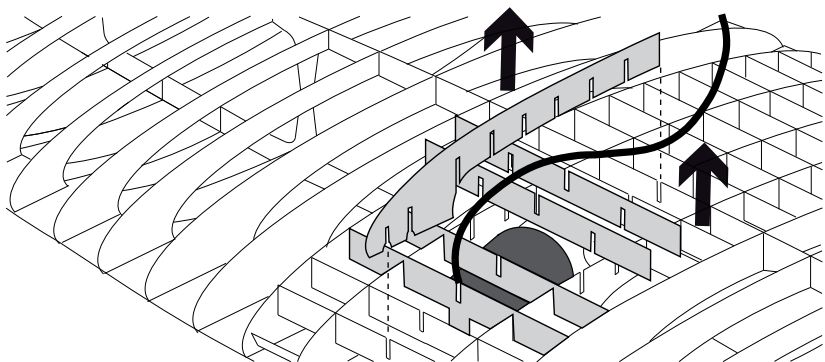

4.3

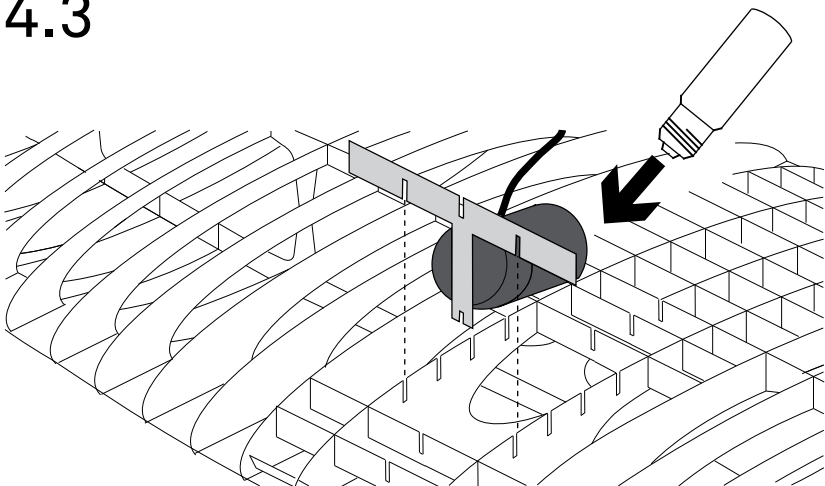

4.4

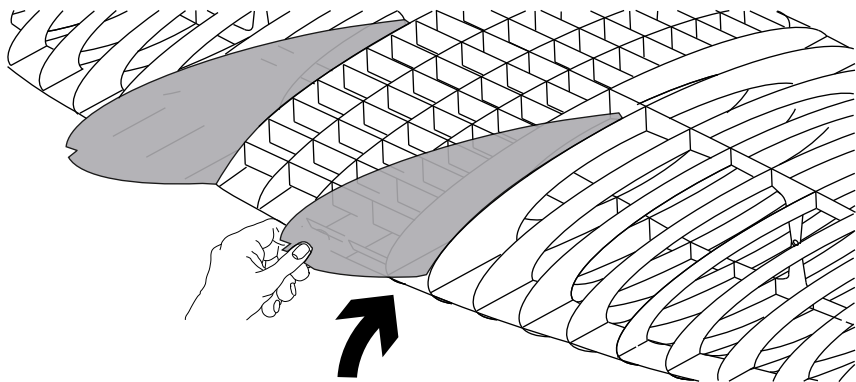
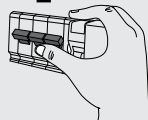
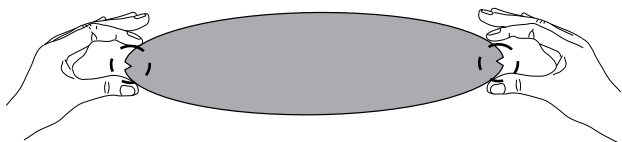



www.luceplan.com

D170IA203